



CATALOG

2023 종합카달로그

Increasing corporate value through
customer satisfaction
We will do my best to achieve that vision



Package



Pizza
Smallwares



Equipment

“

고객 여러분 안녕하십니까?

(주)에이치디엔텍은 고객 여러분의 성원을 바탕으로

"고객 만족을 통한 기업 가치 증대"

라는 비전을 달성하기 위해 최선의 노력을 다하겠습니다.

(주)에이치디엔텍은 1974년 설립되어 지난 49여 년 동안

국내 외식 산업과 더불어 관련 분야를 선도해왔습니다.

창의적인 기술과 아이디어로 끊임없는 연구개발을 통해

해외 50여 개국 수출이라는 성과를 이뤄내기도 했습니다.

요즘과 같이 빠르게 변화하는 트렌드와 고객의 니즈를 충족시키기 위해

전 임직원들은 최선의 노력을 다하고 있습니다.

우리가 흘린 땀 한 방울이 바로 고객의 만족이 된다는 것을 가슴속 깊이 새겨,

"고객 만족을 통한 기업가치 증대"라는 비전을 달성하기 위해

저력과 기술력 그리고 풍부한 노하우를 통해 업계를 선도하는

글로벌 기업으로 거듭날 것을 약속드립니다.

항상 변함없는 관심과 성원 부탁드립니다.

”

대 표 이 사 *권철민*

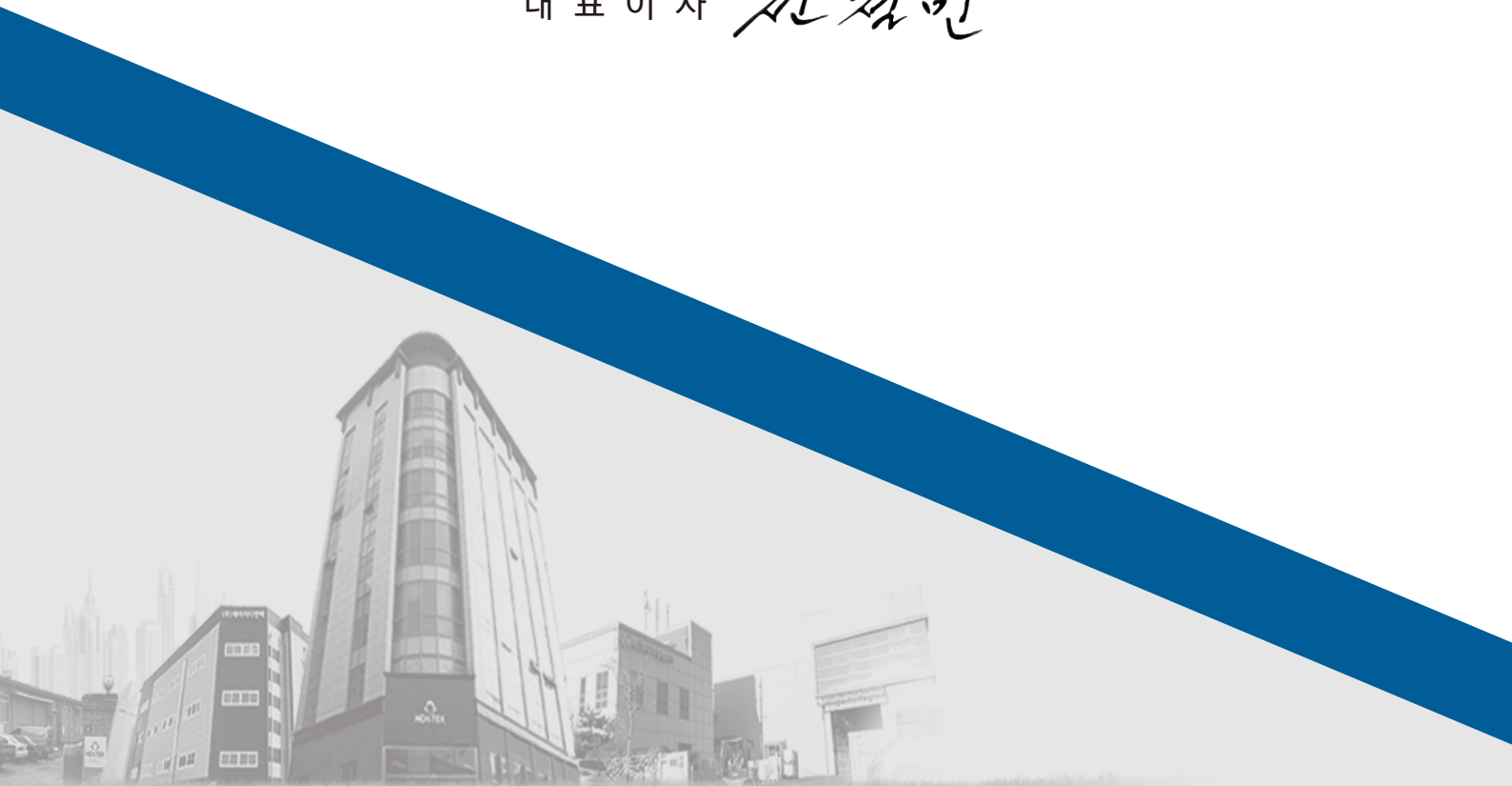



H D&TEK History

● 1970 ~

1974.04 협동사 창업

● 1980 ~

1983.05 의류업체 미국 GAP社에 의류 포장용 BOX 공급

1988.02 한국 피자헛(유)에 피자박스 제품 공급

● 1990 ~

1992.03 미국 YUM社로 부터 Pizza smallware 승인 획득

1994.01 협동종합산업으로 사명 변경

1997.11 한국 피자헛(유) 최우수 협력업체상 수상

1999.04 근흥종합식품(주) 창업

● 2000 ~

2000.02 미국 YUM社 우수협력업체상 수상

2000.03 품질경영시스템 인증 ISO 9001

2000.11 한국 피자헛(유) 최우수 협력업체상 수상

2000.12 유망 중소기업 선정
(신한은행)

2001.09 미국 YUM社 우수협력업체상 수상
(2003, 2004)

2001.11 파주 사출공장 준공

2002.04 인덕션히터(Delivery Heating System) 출시
(국내특허)

2006.11 한국 피자헛(유) 최우수 협력업체상 수상

2007.11 전세계 PizzaHut(55개국) 수출

제 44 회 무역의날 수출탑 수상
(산업자원부 장관)

2008.03 제 42 회 납세자의 날 표창
(국무총리)

● 2010 ~

2010.01 중국 상해법인 설립

2010.10 (주)에이치디앤텍(HD&TEK) 사명 변경

2011.05 본사 사옥 준공

2012.07 ISO 14001 환경경영체제 인증 획득

2012.10 김포패키지 제 1 공장 준공

2013.08 파주 공장 설비 증설

2014.03 제 48 회 납세자의 날 표창
(부총리상 수상)

2014.09 벤처기업확인서 획득

2015.05 기술혁신형 중소기업(INNO-BIZ) 인증

2015.10 김포패키지 제 2 공장 준공

2015.12 제 52 회 무역의날 수출탑 수상
(대통령상)

2016.03 FSC 인증

2016.12 기술평가 우수기업 인증

2018.10 김포패키지 제 3 공장 준공

● 2020 ~

2021.03 제 55 회 납세자의 날 기획재정부장관 표창

2021.07 김포패키지 제 4 공장 착공

2021.08 김포패키지 제 1 공장 칼라옵셋인쇄 2호기 도입
(RMGT 6색수성코터)

2022.06 자동 고속 합지기 도입

2022.12 병역지정업체(산업체) 선정

CONTENTS

01 HD&TEK 설비 안내

- 에이치디애텍 본사
- 김포 1 공장, 김포 2 공장, 김포 3 공장
- 파주공장, 평택물류센터

02 Package

- 식품 박스
- 카페 포장 박스
- 기타 패키지

03 피자 주방용품

04 커피용품

05 주방 장비

- 주방 장비 소개
- Hot Bank System

06 고객사 소개

HD&TEK

설비 안내

에이치디앤텍 본사

김포 1 공장 · 김포 2 공장 · 김포 3 공장

파주공장 · 평택물류센터



● 에이치디앤텍 본사

주소	서울특별시 성동구 연무장5길18 에이치디앤텍 빌딩 / (우)04782
대표전화	02) 3409-1181
Fax	02) 3409-1186
주요업무	고객 상담 및 제품개발, 영업, 물류, 유통까지의 업무 제반 사항에 대한 총괄 관리



서울 사옥 전경



샘플실

● 김포 1 공장 (패키징 제품 생산부)

주소	경기도 김포시 양촌읍 황금2로 72 김포골드밸리내 / (우)10047
대표전화	031) 983-4754
Fax	031) 983-4701
대지	1,200 평
주요업무	- 각종 종이 패키징 박스 및 쇼핑백 생산 - 각종 식품 포장용 박스 및 칼라 박스, 카톤 박스, 쇼핑백 등 종이 패키징 제품 및 친환경 포장 용기 생산 - 최신식 생산 설비 및 자동화 생산 시스템 구축



김포 제 1 공장 전경 [김포골드밸리내]

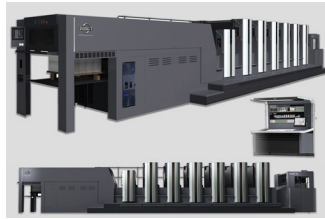

칼라 옵셋 6도인쇄기 [RMGT 6색 수성코터]



습수여과살균시스템 [EP-100]



자동틀스기 1 호기 [아사히 AP-1060-TS-7200IPH]



자동틀스기 2 호기 [아사히 AP-1060-TS-7200IPH]



자동틀스기 3 호기 [영신 -1450R]



접착 1,2,3 호기 [자동 3면-4면]



자동합지기 1 호기 [SHL-1300]



자동합지기 2 호기 [PAKER-1300]



재단기 [Computer Paper Cutter]

● 김포 2 공장 (패키징 제품 생산부)

주소	경기도 김포시 양촌읍 학운산단2로 73 김포골드밸리내 / (우)10049
대표전화	031) 983-4754
Fax	031) 983-4701
대 지	1,500 평
주요업무	- 카톤 박스, 쇼핑백, 선물포장박스 등 각종 패키지 관련 제품들을 다양하게 생산하기 위해 최신 설비와 생산 시스템이 구축되어 있습니다.



김포 제 2 공장 전경 [김포골드밸리내]



자동통슨기 3,4 호기 [아사히 AP-1060-TS-7200IPH]



자동탈지기



합지 3 호기 [고속합지기 SHL-1300]



트레이 접착 1,2,3 호기 [CAT SERIES-600]



컵 홀더 접착 1,2,3,4 호기

● 김포 3 공장 (금 / 은지 증착 생산부)

주소	경기도 김포시 양촌읍 황금2로 70 김포골드밸리내 / (우)10047
대표전화	031) 983-4754
Fax	031) 983-4701
대 지	1,500 평
주요업무	- 금, 은지 증착, 롤 재단



김포 제 3 공장 전경



금은지 합지기



롤컷팅 1 호기



롤컷팅 2 호기



자동통슨 6 호기 [아사히 AP-1060-TS-7200IPH]

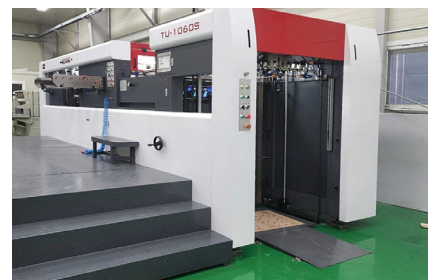

자동통슨 7 호기 [TU-1060S]

● 파주공장 (금속 / 플라스틱 제품 생산부)

주소	경기도 파주시 조리읍 장곡로 91 / (우)10940
대표전화	031) 942-1019
Fax	031) 947-1174
대지	1,000 평
주요업무	- 각종 금속 및 플라스틱 키친 스몰 웨어, 기계 설비류 생산 - 각종 플라스틱 사출 제품 및 금속 프레스, 다이캐스팅 제품 생산 - 자체 금형 개발 (설계 및 제작) 가능, 최신 자동화 설비 구비

● 플라스틱 사출 설비



파주공장 전경



Injection Machine 1 호기 [330Tons]



Injection Machine 2 호기 [280Tons]



Injection Machine 3 호기 [22Tons]



Injection Machine 4 호기 [170Tons]



Injection Machine 5 호기 [170Tons]



Laser Machine (레이저)



Offset Machine (절곡기)

● 금속 가공 설비

Pressure Machine 1, 2 호기
200Tons (유압프레스)Pressure Machine 3 호기
160Tons (유압프레스)Rivet Press Machine
(리벳프레스)

CS50

● 평택물류센터

주소	경기도 평택시 진위면 경기대로 1713-63 / (우)17706
대표전화	031) 983-4754
Fax	031) 611-4754
대 지	7,000 평
주요업무	- 선진화된 재고관리 시스템과 자동화 입출고 시스템 적용을 통한 물류 효율성 및 정확성 극대화 - 자체 배송 차량 보유



평택물류센터 전경



평택물류센터 전경



평택물류센터 내부



평택물류센터 내부



Package

식품포장박스 전문

기획부터 개발까지, 트렌드와 고객의 니즈를 만족시키는
패키징 전문 회사입니다.



● 식품박스



피자박스



치킨박스

• 카페 포장 패키지



카페 포장



컵캐리어



쇼핑백



종이봉투

● 기타 패키지



비닐봉투



유산지



트레이



엠보싱지



캘린더



스파게티 용기 (알루미늄) 대/소



피자 주방용품

음식의 조리방법을 고려한 최적의 상품

축적된 기술과 노하우를 바탕으로,
고객이 만족할 때까지 끊임없는 연구와
노력을 기울이고 있습니다.



● Deep Dish Pans, Black Hard Anodized

ITEM No.	SIZE	PACKING
12005001	6"	12/Case
12005005	7.5"	12/Case
12005007	9"	12/Case
12005008	10"	12/Case
12005010	10.5"	12/Case
12005012	11"	12/Case
12005014	12"	12/Case
12005016	13"	12/Case
12005018	14"	12/Case
12005020	15"	12/Case



● Deep Dish Pan Separators, White

ITEM No.	SIZE	PACKING
12037001	6"	24/Case
12037004	7.5"	24/Case
12037006	9"	24/Case
12037007	10"	24/Case
12037009	10.5"	24/Case
12037011	11"	24/Case
12037013	12"	24/Case
12037015	13"	24/Case
12037019	14"	24/Case
12037021	15"	24/Case



● Deep Dish Pan Rings, White

ITEM No.	SIZE	PACKING
12039005	6"	24/Case
12039006	7.5"	24/Case
12039042	9"	24/Case
12007000	10"	24/Case
12039008	10.5"	24/Case
12039009	11"	24/Case
12039043	12"	24/Case
12039011	13"	24/Case
12039012	14"	24/Case
12039013	15"	24/Case



- Perforated Pans, Silver Anodized

ITEM No.	SIZE	PACKING
12017026	4.5"	24/Case
12017000	6"	24/Case
12017001	7.5"	24/Case
12017002	9"	24/Case
12017003	10"	24/Case
12017004	10.5"	24/Case
12017006	11"	24/Case
12071113	11.5"	24/Case
12017007	12"	24/Case
12017008	13"	24/Case
12017010	14"	24/Case
12017012	15"	24/Case
12017013	16"	24/Case



- Perforated Pan Separators, Elevated, White

ITEM No.	SIZE	PACKING
12037026	6"	12/Case
12037028	7.5"	12/Case
12037030	9"	12/Case
12037033	10"	12/Case
12037036	10.5"	12/Case
12037039	11"	12/Case
12037113	11.5"	12/Case
12037041	12"	12/Case
12037045	13"	12/Case
12037048	14"	12/Case
12037051	15"	12/Case
12037052	16"	12/Case



- Perforated Pan Rings, Burgundy

ITEM No.	SIZE	PACKING
12039005	6"	24/Case
12039015	9"	24/Case
12039016	10"	24/Case
12039017	10.5"	24/Case
12039018	11"	24/Case
12039051	11.5"	24/Case
12039019	12"	24/Case
12039020	13"	24/Case
12039021	14"	24/Case
12039022	16"	24/Case



- Sicilian Pan (Breadstick Pan), Black Hard Anodized

ITEM No.	SIZE	PACKING
12015001	9"x13"	12/Case



- Half Sicilian Pan, Black Hard Anodized

ITEM No.	SIZE	PACKING
12015002	9"x6.8"	12/Case



- Sicilian Pan Separator, White

ITEM No.	SIZE	PACKING
12037023	9"x13"	12/Case



- Half Sicilian Pan Separator, White

ITEM No.	SIZE	PACKING
12039057	9"x6.8"	12/Case



- Sicilian Pan Ring, White

ITEM No.	SIZE	PACKING
12039004	9"x13"	12/Case

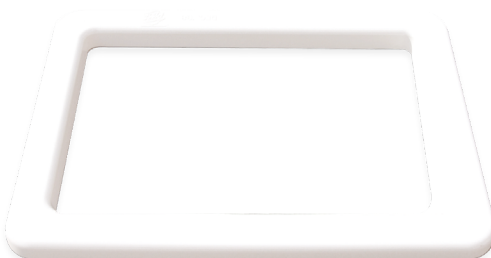

- Half Sicilian Pan Ring, White

ITEM No.	SIZE	PACKING
12039058	9"x6.8"	12/Case



- Square Deep Dish Pizza Pan, Black Hard Anodized

ITEM No.	SIZE	PACKING
12005022	9" x 9"	12/Case



- Square Deep Dish Pizza Pan Separator, White

ITEM No.	SIZE	PACKING
12037053	9" x 9"	12/Case



- Square Deep Dish Pizza Pan Ring, White

ITEM No.	SIZE	PACKING
12039000	9" x 9"	12/Case



- Rectangular Pan, Silver Anodized

ITEM No.	SIZE	PACKING
12004004	12" x 4"	24/Case



- Rectangular Perforated Pan, Silver Anodized

ITEM No.	SIZE	PACKING
12017036	260 x 140mm	24/Case



- Rectangular Perforated Pan Separator, Transparent

ITEM No.	SIZE	PACKING
12037072	270 x 150mm	12/Case



• Square Perforated Pans, Silver Anodized

ITEM No.	SIZE	PACKING
12017019	9" x 9"	24/Case
12017020	11" x 11"	24/Case
12017021	12" x 12"	24/Case
12017022	13.5" x 13.5"	24/Case

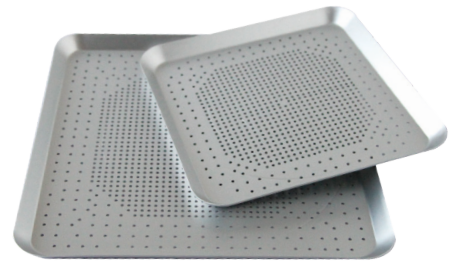

• Square Perforated Pan Separators, Elevated, White

ITEM No.	SIZE	PACKING
12037054	9" x 9"	12/Case
12037057	11" x 11"	12/Case
12037059	12" x 12"	12/Case
12037060	13.5" x 13.5"	12/Case



• Square Perforated Pan Rings, White

ITEM No.	SIZE	DESCRIPTION	PACKING
12039001	9" x 9"	Used for EDGE Pizza	24/Case
12039002	12" x 12"	Used for EDGE Pizza	24/Case
12039003	13.5" x 13.5"	Used for EDGE Pizza	24/Case



- Pizza Screens, Black Hard Anodized

ITEM No.	SIZE	PACKING
12022000	6"	25/Case
12022001	7"	25/Case
12022003	8"	25/Case
12022004	9"	25/Case
12022005	10"	25/Case
12022006	11"	25/Case
12022007	12"	25/Case
12022009	12.6"	25/Case
12022010	13"	25/Case
12022012	14"	25/Case
12022013	15"	25/Case
12022014	16"	25/Case
12022015	17"	25/Case
12022016	18"	25/Case



- Topping Rings

ITEM No.	SIZE
13027029	9" (200mm)
13027030	10" (220mm)
13027031	11" (255mm)
13027034	12" (285mm)
13027035	13" (305mm)
13027037	15" (355mm)
13027039	18" (430mm)



- Square Pizza Screens, Black Hard Anodized

ITEM No.	SIZE	PACKING
12022018	11.5" x 11.5"	25/Case
12022019	14" x 14"	25/Case

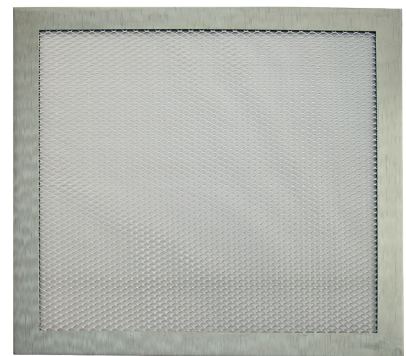

- Garlic Bread Screens

ITEM No.	SIZE	PACKING
12022021	311 x 120mm	25/Case
12022023	360 x 120mm	25/Case

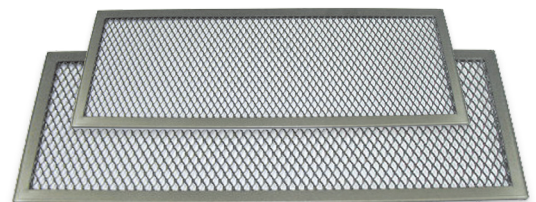

• Thin Pans(Non-perforated), Silver Anodized

ITEM No.	SIZE	PACKING
12016002	7.5"	24/Case
12016005	9"	24/Case
12016006	10"	24/Case
12016007	10.5"	24/Case
12016009	12"	24/Case
12016012	13"	24/Case
12016016	14"	24/Case
12016013	15"	24/Case



• Pizza Disks

ITEM No.	SIZE	PACKING
12017033	9"	25/Case
12017014	10"	25/Case
12017073	10.5"	25/Case
12017024	12"	25/Case
12017074	12.5"	25/Case
12017015	13"	25/Case
12017066	14"	25/Case
12071000	15"	25/Case
12071106	16"	25/Case
12017017	18"	25/Case

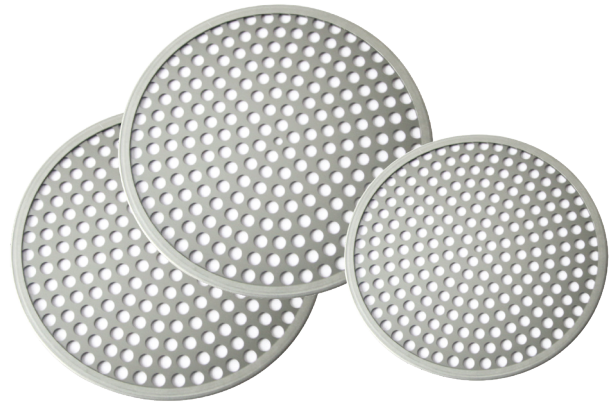

• Chicago Pizza Ring

ITEM No.	SIZE	PACKING
12001017	10"	25/Case



- 피자 스크린 및 디스크를 사용하여 사용자 지정 크기로 사용할 수 있습니다.



- Cutting Boards, Square, No Handle

ITEM No.	SIZE
13031000	16"x16"
13031001	18"x18"
13031002	19.25"x19.25"
13031003	20"x20"



- Serving Boards, Round, 5" Handle

ITEM No.	SIZE
13031004	7"
13031020	8"
13031005	9"
13031006	10"
13031007	11"
13031008	12"
13031009	13"
13031010	14"
13031011	16"
13031012	18"
13031013	20"

- 온수 및 비눗물로 세척을 권고하며 뒤틀림에 저항할 수 있는 비다공성 표면을 가지고 있습니다
- 커스터마이징 가능합니다



- Cork Mats

ITEM No.	SIZE	PACKING
13071008	428mm	10/Case
13071006	383mm	10/Case
13071005	355mm	10/Case
13071003	268mm	10/Case
13071002	255mm	10/Case
13071000	205mm	10/Case



- 커스터마이징 가능합니다



● Dough Trays

ITEM No.	COLOR	SIZE
13114000	Gray	660*455*80mm
13114003	Red	650*450*80mm
13114005	Yellow	650*450*80mm

- 도우 숙성 및 발효 등 보관에 용이하고 트레이를 쌓아서 사용 가능합니다 .



● Dough Tray Lids

ITEM No.	COLOR	SIZE
13114017	Gray	650*450*40mm
13114009	Red	650*450*40mm
13114011	Yellow	650*450*40mm



● Dough Tray Dolly, Black Steel

ITEM No.
13079000



● Dough Tray Dolly with Handle, Stainless Steel

ITEM No.
13079001



● Dough Scraper

ITEM No.	COLOR
12047000	White



- Dough Stamper

ITEM No.	COLOR
12033000	White



- Oil Jar

ITEM No.	SIZE
13052000	One gallon(3.78)



- Oil Pumps

ITEM No.	DELIVERY VOLUME
12045000	7g, Black
12045001	10g, White
12045005	15g, Burgundy
12045009	17g, Burgundy
12045008	20g, Blue
12045004	22g, Blue



- Gap Gauge

ITEM No.
12032002

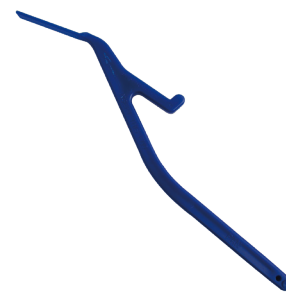

- Water Jars

ITEM No.	CAPACITY
13069091	250cc
13069054	500cc
13069092	1000cc
13069093	2000cc
13069094	4000cc



● Rocking Knife

ITEM No.	DESCRIPTION
13064004	517mm length



● Rocking Knife Base

ITEM No.	DESCRIPTION
13064018	Hold a Rocking Knife
13064043	Rocking Knife Base For 3 Knives



● In Pan Cutter

ITEM No.	DESCRIPTION
13064019	6", Used for personal pan pizzas.

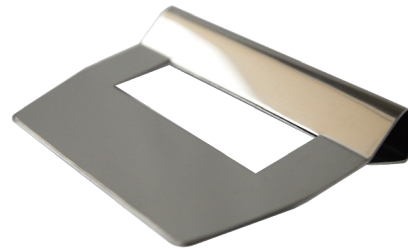

● Cutting Wheels

ITEM No.	WHEEL SIZE
13064000	4"
13064001	5"



● Notched Cutting Wheel

ITEM No.	WHEEL SIZE
13064002	2.7"



● Volcano Cutting Wheel

ITEM No.	WHEEL SIZE
13064003	2.9"/2.6"



- Dough Crimper

ITEM No.
12030001



- Pan Gripper

ITEM No.	DESCRIPTION
13061000	Cast aluminum alloy with elastomeric spring.



- Dough Perforator

ITEM No.	DESCRIPTION
12035001 (Big)	5" overall length. Use to aerate dough.
12035000 (Small)	



- Dough Trimmer

ITEM No.	DESCRIPTION
12034000	Used to remove excess dough from pan edge.



- Pizza Servers

ITEM No.	PACKING	SIZE
13083000	100/Case	2" x 4" blade
13083004	100/Case	2.7" x 8" blade



● Pizza Server, Stainless Steel

ITEM No. _____
13083001



● Squeeze Bottle

ITEM No. _____ CAPACITY _____
13030001 24 oz



● Check Minders with ball bearing

ITEM No.	SIZE
13050000	457mm
13050001	600mm
13050002	760mm
13050003	900mm
13050004	1200mm



- 구슬이 내재된 레시피 홀더 (알루미늄)
- 커스터마이징 가능합니다

● Check Minders

ITEM No.	SIZE
13050005	457mm
13050006	600mm
13050007	760mm
13050008	900mm
13050009	1,000mm
13050010	1,200mm

- 구슬없는 레시피 홀더 (스테인리스 스틸)



- Salad Tongs / Spoon

ITEM No.	LENGTH
12048000	8.5" / Tong
12048001	12" / Tong
12044000	10" / Spoon



- Can Openers

ITEM No.	DESCRIPTION
13065006	Can Opener.#3
13065002	Portable Can Opener



- Pizza Pan Rack

ITEM No.
13023000

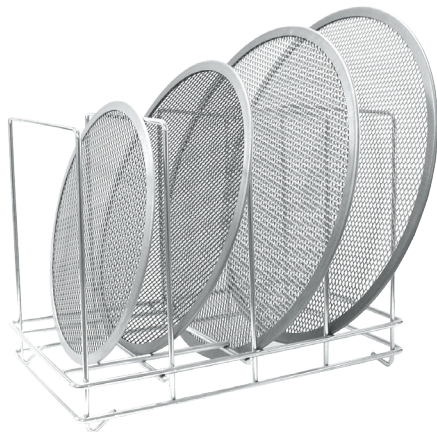

- Pizza Screen Rack

ITEM No.
13023001

- 최대 80 개까지 보관가능합니다

• Thermometers, Pocket

ITEM No.	RANGE
13054004	0 to 220° F, -10 to 100° C
13054003	-10 to 100° C
13054002	-40 to 70° C



• Sauce Spoon, Stainless Steel

ITEM No.
13047005



• Pizza Shovels, Aluminum Handle

ITEM No.	BLADE SIZE	OVERALL
12021013	12"	28"
12021014	14"	28"
12021017	12"	48"
12021004	14"	48"
12021016	12"	35"



• Salad Crocks

ITEM No.	CAPACITY	HEIGHT	TOP DIAMETER
12053000	1.4L	4 3/8"	6 3/4"
12053001	2.5L	6 7/8"	6 3/4"



- 커스터마이징 가능합니다

- Pizza Bubble Poppers

ITEM No.	OVERALL
13006001	39"
13006000	53"

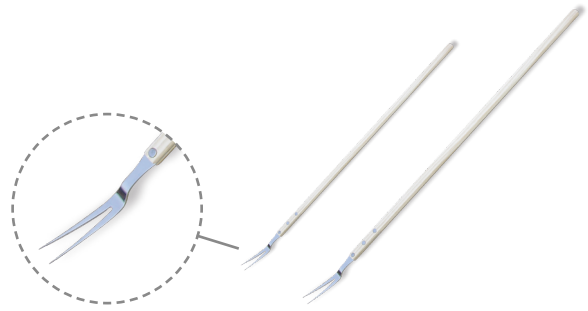

- Rubber Scraper

ITEM No.	DESCRIPTION
13060001	16-1/2" Length. Dishwasher safe.



- Chicken Wing Grills

ITEM No.	SIZE
13056000	140mm
13056002	200mm
13056004	280mm
13056005	300mm

딤디쉬팬과 호환하여 사용 가능합니다

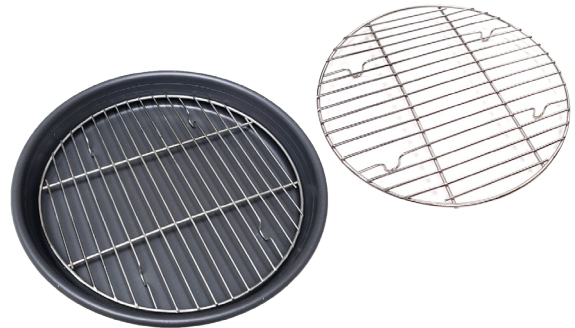

- Heat Pin

	ITEM No.	PACKING
Heat Pin (Teflon Coating)	13117000	36/Case
Heat Pin (Hard Anodized)	12023003	36/Case

- 피자, 라자냐, 왕봉 등 재료의 내부까지의 전열을 돕기 위해 사용됩니다
- Heat Pin 은 매번 사용 후 세척해야 합니다 .
- 세게 닦지 말고 부드러운 천으로 깨끗이 닦으세요 .

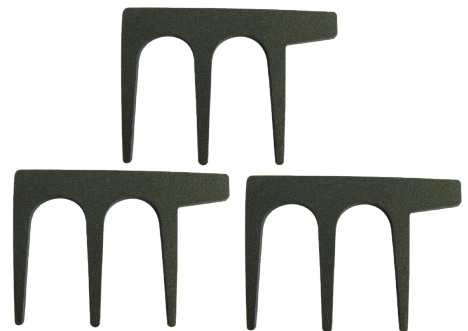

● Soft drink Bags

ITEM No.	DESCRIPTION
13095001	Large Size
13095002	Small Size



● Delivery Pouches

ITEM No.	DESCRIPTION
33001087	KFC Delivery Bag (Chicken)
33001088	KFC Delivery Bag (Drink)
33001102	Pizza Hut Delivery Bag



● Lid Supports

ITEM No.	PACKING
13034000	2000/Case

- 피자박스 지지대



● Plastic Fork

ITEM No.	COLOR	PACKING
12055036	White	500/Case
12055037	Black	500/Case



- Pizza Stands

ITEM No.	DESCRIPTION
13038007	Circle
13038009	Square



- Tumblers

ITEM No.	DESCRIPTION
12051020	Red 12oz
12051031	Red 16oz
12051021	Clear 12oz
12051036	Clear 22oz



- Table Menu Stands

ITEM No.
12038001



- Condiment Holder

ITEM No.
13023003



● Cutlery

ITEM No.	DESCRIPTION
13081004	Dinner Fork
13012000	Dinner Knife
13047021	Dinner Spoon



● Cola Pitcher, 1700cc

ITEM No.
12051041



● Chicken Baskets

ITEM No.	COLOR or Material
13038006	Stainless Steel
12071100	Black
12071101	Yellow



● Garlic Bread Basket

ITEM No.
13038000



● Organizer Rack With Bins

ITEM No.
12055SET

-1 세트당 6 개





• Regular Steam Table Pans

PAN SIZE AND DIMENSIONS		ITEM No.	DESCRIPTION	PACKING
	Full (1/1) Size Pan 20-3/4"x12-3/4" (530x325mm)	13029032	1.2"(32mm)DEEP	12/Case
		13029033	2.5"(65mm)DEEP	12/Case
		13029034	4.0"(100mm)DEEP	12/Case
		13029035	6.0"(150mm)DEEP	12/Case
		13029036	8.0"(200mm)DEEP	12/Case
	Two Third (2/3) Size Pan 13-7/8"x12-3/4" (354x325mm)	13029039	2.5"(65mm)DEEP	24/Case
		13029040	4.0"(65mm)DEEP	24/Case
		13029041	6.0"(100mm)DEEP	12/Case
		13029042	8.0"(150mm)DEEP	12/Case
	One Half (1/2) Size Pan 12-3/4"x10-3/8" (325x265mm)	13029045	1.2"(32mm)DEEP	24/Case
		13029046	2.5"(65mm)DEEP	24/Case
		13029047	4.0"(100mm)DEEP	24/Case
		13029048	6.0"(150mm)DEEP	12/Case
		13029049	8.0"(200mm)DEEP	12/Case
	One Third (1/3) Size Pan 12-3/4"x6-7/8" (325x176mm)	13029052	2.5"(65mm)DEEP	48/Case
		13029053	4.0"(100mm)DEEP	24/Case
		13029054	6.0"(150mm)DEEP	24/Case
	One Quarter (1/4) Size Pan 10-3/8"x6-3/8" (265x162mm)	13029057	2.5"(65mm)DEEP	72/Case
		13029058	4.0"(100mm)DEEP	48/Case
		13029059	6.0"(150mm)DEEP	48/Case
	One Sixth (1/6) Size Pan 6-7/8"x6-1/4" (176x162mm)	13029062	2.5"(65mm)DEEP	72/Case
		13029063	4.0"(100mm)DEEP	48/Case
		13029064	6.0"(150mm)DEEP	48/Case
	One Ninth (1/9) Size Pan 6-7/8"x4-1/4" (176x108mm)	13029067	2.5"(65mm)DEEP	72/Case
		13029068	4.0"(100mm)DEEP	72/Case

• Covers

	PAN SIZE	SOLID COVERS	PACKING	SLOTTED COVERS	PACKING
	1/1 Size Coverage	13029037	24 / case	13029038	24 / case
	2/3 Size Coverage	13029043	24 / case	13029044	24 / case
	1/2 Size Coverage	13029050	24 / case	13029051	24 / case
	1/3 Size Coverage	13029055	24 / case	13029056	24 / case
	1/4 Size Coverage	13029060	24 / case	13029061	24 / case
	1/6 Size Coverage	13029065	24 / case	13029066	24 / case
	1/9 Size Coverage	13029069	24 / case	13029070	24 / case

● Polycarbonate Food Pans

PAN SIZE AND DIMENSIONS		ITEM No.	DESCRIPTION	PACKING
	Full (1/1) Size Pan 20-3/4"x12-3/4" (530x325mm)	13029000	2.5"(65mm)DEEP	12/Case
		13029001	4.0"(100mm)DEEP	12/Case
		13029002	6.0"(150mm)DEEP	12/Case
		13029003	8.0"(200mm)DEEP	12/Case
	One Half (1/2) Size Pan 12-3/4"x10-3/8" (325x265mm)	13029006	2.5"(65mm)DEEP	24/Case
		13029007	4.0"(100mm)DEEP	24/Case
		13029008	6.0"(150mm)DEEP	12/Case
		13029009	8.0"(200mm)DEEP	12/Case
	One Third (1/3) Size Pan 12-3/4"x6-7/8" (325x176mm)	13029012	2.5"(65mm)DEEP	24/Case
		13029013	4.0"(65mm)DEEP	24/Case
		13029014	6.0"(100mm)DEEP	24/Case
		13029015	8.0"(150mm)DEEP	12/Case
	One Quarter (1/4) Size Pan 10-3/8"x6-3/8" (265x162mm)	13029018	2.5"(65mm)DEEP	36/Case
		13029019	4.0"(100mm)DEEP	36/Case
		13029020	6.0"(150mm)DEEP	24/Case
	One Sixth (1/6) Size Pan 6-7/8"x6-1/4" (176x162mm)	13029023	2.5"(65mm)DEEP	36/Case
		13029024	4.0"(100mm)DEEP	48/Case
		13029025	6.0"(150mm)DEEP	24/Case
	One Ninth (1/9) Size Pan 6-7/8"x4-1/4" (176x108mm)	13029028	2.5"(65mm)DEEP	72/Case
		13029029	4.0"(100mm)DEEP	72/Case

● Covers

	PAN SIZE	SOLID COVERS	PACKING	SLOTTED COVERS	PACKING
	1/1 Size Coverage	13029004	24 / case	13029005	24 / case
1/2 Size Coverage	13029010	48 / case	13029011	48 / case	
1/3 Size Coverage	13029016	72 / case	13029017	72 / case	
1/4 Size Coverage	13029021	72 / case	13029022	72 / case	
1/6 Size Coverage	13029026	72 / case	13029027	72 / case	
1/9 Size Coverage	13029030	72 / case	13029031	72 / case	

● PC Drain Shelf

	SIZE	ITEM No.	PACKING
	1/1 Size Coverage	13029071	20 / case
1/2 Size Coverage	13029072	40 / case	
1/3 Size Coverage	13029073	80 / case	
1/4 Size Coverage	13029074	80 / case	
1/6 Size Coverage	13029075	120 / case	

커피용품

사용자 중심의 디자인과 설계

컨디먼트바 인서트 부자재, 컵홀더 디스펜서, 머그트리, 블랙플래터, 머들러, 컵홀더, 베이글커터 등 커피 전문점 어디에서나 사용가능합니다.



• 나우브루잉 이젤 (NOW BREWING)



• 내부 홍보물 거치대



• 계량컵 (Measuring Cup)

ITEM NO. _____
13078035



• 머들러 (Muddler)

ITEM NO. _____
13047017



• 머그컵 (Mug Cup)



• 머그트리 (Mug Tree)

ITEM NO. _____
13030003



- 티켓스탠드



- 초콜릿 케이스



- 캔디바



- 플라스틱컵 (Pet cup & Lid)



- 컵홀더 (Cup Holder)



- 베이글커터
(Bagel Cutter)



ITEM NO.
13066000

- 냅킨보관함
(Napkin Dispenser)



ITEM NO.
12029000

- 컵홀더 디스펜서
(Cup Holder Dispenser)



• 컨디먼트바 인서트 부자재
(Condiment Bar Utensil)

ITEM NO.	DESCRIPTION
13049022	Cup Disposabble Container
13049025	Recycle
13049026	Trash
13049027	Liquid



• 블랙플래터 (Black Platter)

ITEM NO.	SIZE
12059000	L (265 x 325mm)
12059002	M (176 x 325mm)
12059001	S (265 x 162mm)

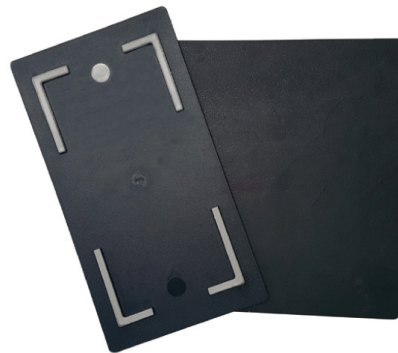

• 우산 빗물제거기



• 등신대 (Full Size Portrait)



• 우산 거치대



외식업소용 주방장비

독보적인 최고의 기술력

브로일러, 피자 가스오븐, 언더카운터 온수기, 도우프레스, 블럭치즈분쇄기, 컵워머, 머그랙은 에이치디앤텍만의 기술력이 집약된 제품입니다.



● 브로일러



모델명	TY-500N
외형 규격 (WxDxH)	720 x 823 x 773 mm (그릴포함 720 x 950 x 773)
가스사양	도시가스 13A
정격 사용온도	360 °C
예열 시간	약 10 분 ~20 분
냉각 시간	약 20 분
전 원	AC220V, 40W
재 질	스테인리스
가스 소비량	10.5 kW
컨베어 폭	12 인치
컨베어 속도	1 분 ~16 분

● 피자 가스오븐



19.5 인치

모델명	SY-1950P (LPG) SY-1950N (LNG)	전 원	AC220V, 60Hz, 300W
외형 규격 (WxDxH)	1190 x 850 x 435(mm)	재 질	스테인리스
열 량	LPG : 0.95kg/h LNG : 11,500kal	노즐 규격	LPG(1.4mm x 2) LNG(1.8mm x 2)
정격 사용온도	300 °C	중 량	116kg
예열 시간	6 분 50 초	피자팬 최대 규격	19.5 인치
냉각 시간	20 분	컨베어 속도	3 분 ~ 25 분

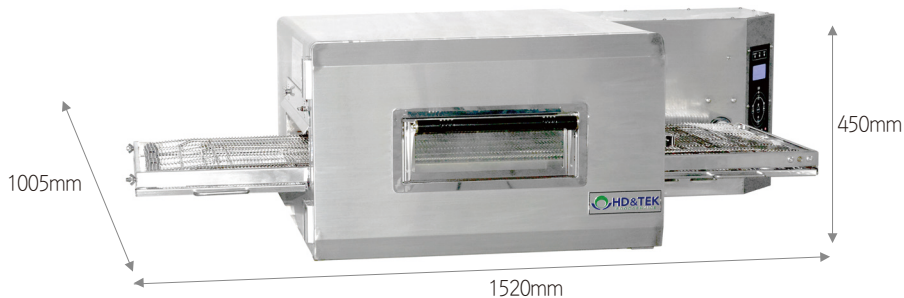

21 인치

모델명	SY-2100P (LPG) SY-2100N (LNG)	전 원	AC220V, 60Hz, 300W
외형 규격 (WxDxH)	1520 x 1005 x 450(mm)	재 질	스테인리스
열 량	LPG : 0.97kg/h LNG : 12,500kal	노즐 규격	LPG(2mm x 1) LNG(3mm x 1)
정격 사용온도	300 °C	중 량	130kg
예열 시간	6 분 50 초	피자팬 최대 규격	21 인치
냉각 시간	20 분	컨베어 속도	3 분 ~ 25 분

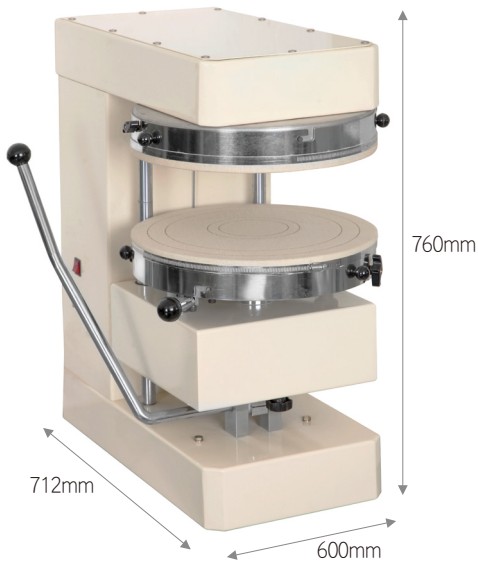

● 도우 프레스 (Dough Press)

전 원	220V
소비전력	400W
제품중량	120kg
규격 (WxDxH)	600 x 712 x 760(mm)
도우사이즈	최대 14 인치
사용용도	피자 도우를 규격에 맞게 펴는데 사용

Features

1. 간단한 조작으로 도우를 규격에 맞게 펴주어 사용이 편리합니다.
2. 사용법에 따라 원하는 도우 사이즈를 제작할 수 있습니다.

● 피자 도우 롤러기

전 원	220V, 60Hz
소비전력	400W
제품중량	82kg
규격 (WxDxH)	600 x 580 x 650(mm)

Features

1. 피자 도우를 균일한 압력으로 눌러 얇게 펴주는 기능의 제품
2. 롤러의 간격 조절이 가능하여 도우의 두께를 원하는 높이로 만들어 줍니다.
3. 품질이 우수하여 장기간 사용이 가능하며, 유지관리가 편리합니다.

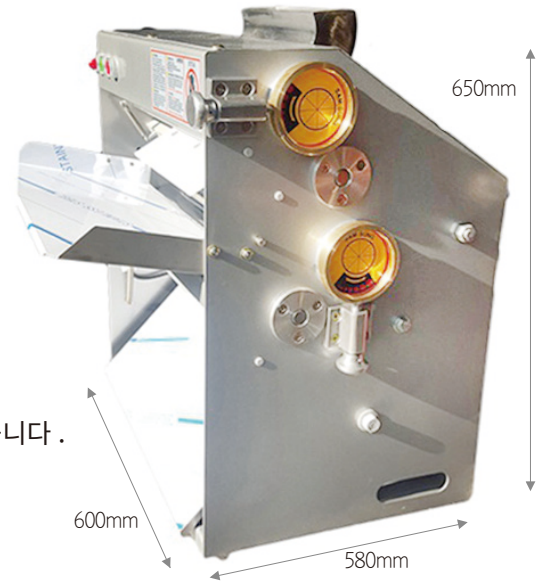

● 블럭 치즈 분쇄기 (Cheese Cutter)

전 원	220V
정격전압	220V, 60Hz
정격입력	210W
규격 (WxDxH)	230 x 415 x 515(mm)

Features

1. 전기방식의 치즈 커터기입니다.
2. 스테인리스 구조로 녹이 슬지 않으며, 위생적입니다.
3. 블록 치즈를 직접 가공하여 슈레드치즈를 제작함으로써 가공비가 절감됩니다.
4. 커터기를 사용함으로써 가공치즈에 비해 저장성이 용이합니다.
5. 치즈 굵기를 조절할 수 있습니다.
6. 소음이 적으며 부드럽게 작동됩니다.

● 언더카운터 온수기 (HD-UHWD-2111)

정격전압	220V / 3kW
규격 (WxDxH)	본체 210 x 340 x 561(mm) 수전 30 x 150 x 300(mm)
물탱크 용량	7L
설정 가능 온도	85°C ~ 95°C

Features

1. 85°C 이하로 물 온도가 떨어질 경우 추출이 중단되며, 설정 온도로 복귀되면 다시 추출 가능
2. 정수와 온수를 음료 용량별로 추출할 수 있으며, 추출 버튼 중 임의의 버튼을 길게 누르면 자유 급수가 가능합니다. 두 개의 추출구에서 정수와 온수가 나눠 추출됩니다.
3. 설정 방식이 기존 자동 급수형 핫 워터 디스펜서와 동일하여 파트너 분들도 쉽게 조작이 가능합니다.

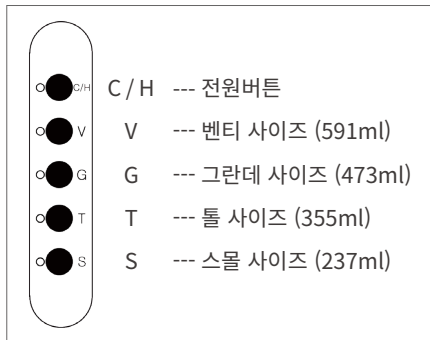
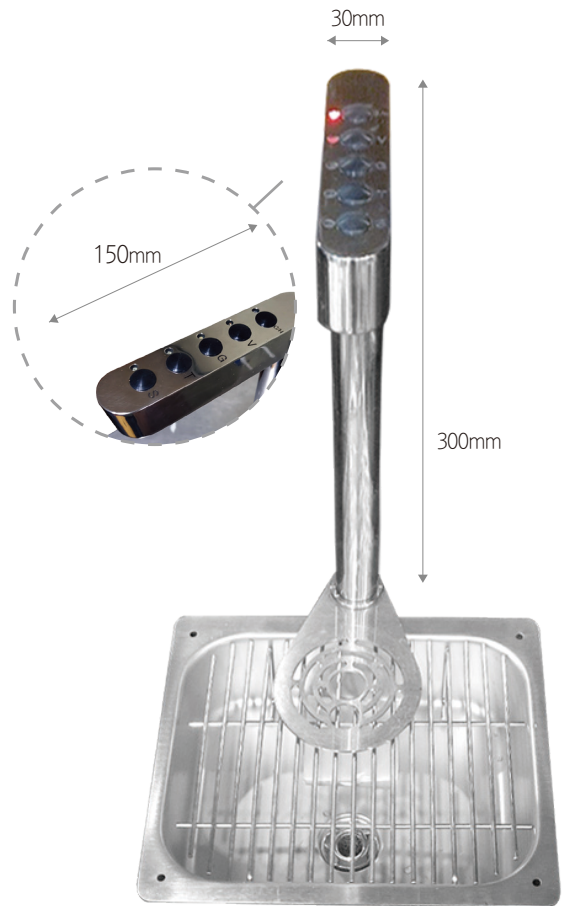

버튼설명



전체구성

● 디지털 핫 워터 디스펜서 (Digital Hot Water Dispenser)

전 원	220V
정격용량	7L
정격전압	220V
규격 (WxDxH)	305 x 315 x 490(mm)
정격입력	3000W
최초발열시간	설정 사양에 따라 다름 (참고 : 물 온도 97°C 설정 시 약 15 분 소요)

Features

1. 0.1 초 단위의 세팅으로 정확한 물 용량의 취수가 가능합니다.
2. 버튼식으로 되어 있어 작동이 편리합니다.
3. 많은 물을 취수하여도 온도 복원 속도가 빠릅니다.(85°C→ 95°C 약 4 분 소요)
4. 자유 급수가 가능합니다.



Tip! 설정 전 원하는 물의 중량을 몇 초로 세팅하면 되는지, 세팅 값을 알아둡니다. (0.1초당 4~4.5ml 취수)

	Small	Regular	Large	X-Large
물 용량 (ml)	207	295	383	471
시간 (sec)	4.8	6.8	8.8	10.8

● 컵워머 (Cup Warmer, W.Heater)

정격접압	220V, 60Hz, 0.8kW
규격 (WxDxH)	255 x 425 x 550(mm)
컵 개수	36 개 (선반 한 층에 9 잔씩 4 칸)

Features

1. 머그컵을 오랫동안 따뜻하게 데워줍니다.
2. 최대 36 개 컵을 보관할 수 있습니다. (선반 한 층에 9 잔씩 4 칸)
3. 컵의 보온과 일정 온도를 유지함으로써, 커피 맛을 오랫동안 지속하게 합니다.

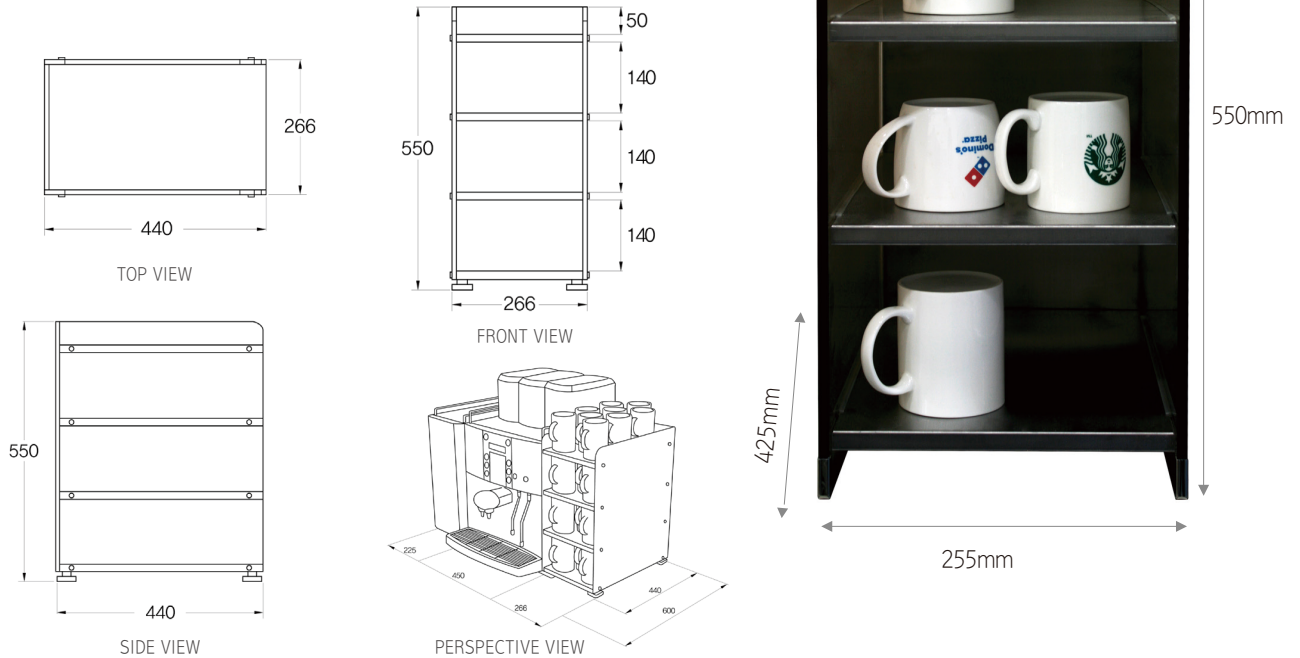

● 머그랙 보관함 (Mug Rack Storage)

규격 (WxDxH) 430 x 700 x 840(mm)

Features

1. 세척한 머그잔을 보관하는 수납장 형태이며 하단에는 물받이가 있습니다.

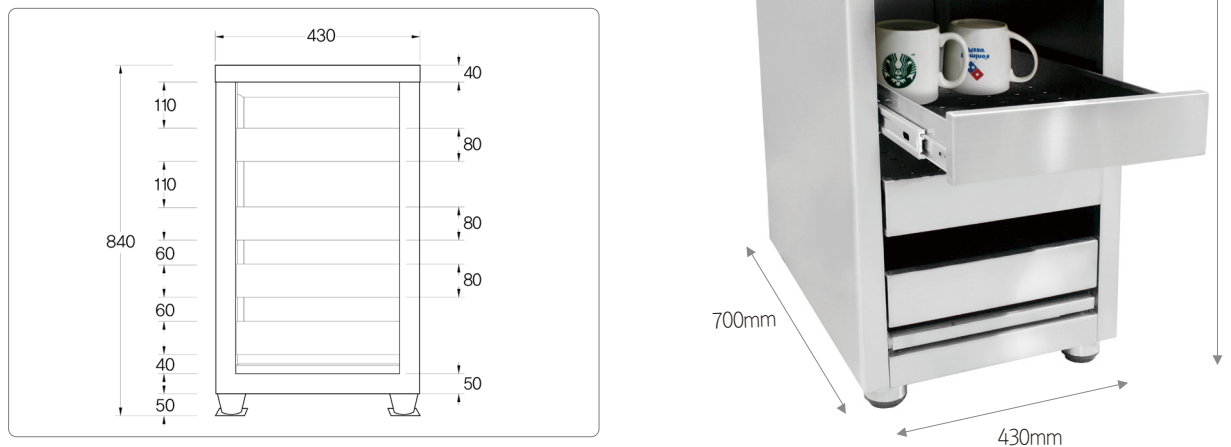

Hot Bank Induction Heating Delivery System

Features

HOT BANK(인덕션 히팅 시스템) 는 피자를 배달할 때 , 히팅기에 의해 가열된 특수 가방에 넣어서 배달함으로써 오븐에서 갓 구워낸 맛 그대로의 따뜻한 피자를 고객에게 배달할 수 있는 시스템입니다. 자체 특허 기술을 통해 개발한 인덕션 히터 및 전용 파우치를 통해 매장 내 사용에 안전성과 간편성을 더하였으며 , 어떠한 환경에서도 피자 의 최적 온도 (75°C ~80°C)를 유지시켜주는 최첨단 고객만족 시스템입니다 .

● Delivery Pouches

33001081 / Fabric, Black

- * 배달가방은 일반 가방에서 발생하는 습을 제거하는 신소재가 내장되어 있으며, 내구성이 강합니다.
- * 히팅 된 가방 내부 온도는 약 30 분 동안 75°C ~80°C 으로 유지되어 항상 갓 구워낸 피자를 맛보실 수 있습니다 .



● Induction Heater

32001000 / 220V

- * 조작성 간편하고 , 유지 보수가 거의 필요하지 않습니다 .
- * 기계 내부에 자가 진단 기능이 있어 문제 발생시 경보음 및 자동 OFF 가 됩니다 .
- * 인덕션 히팅기로서 기계 자체에는 열이 전혀 없으며 , 가볍고 사용이 간편합니다 .
- * 금속 제품은 절대 올리지 마십시오 (알루미늄 , 스테인리스 제품)



● Heating Pellet

33003000 / Heating Pellet

- * 특수 강철 소재와 합성수지를 사용해 열을 오랫동안 유지할 수 있으며 , 최대 400°C까지 견딜 수 있도록 제작되어 있습니다. (자동 온도 제어 센서 부착)
- * 특수 제작된 합성수지로, 가열 시 발생하는 냄새가 전혀 없고, 식품에 안전합니다 .



● Heat Barrier Plate

- * 열 손실을 방지하는 특수 소재로 제작되었습니다 .



Instruction

1. 특수 열 보존형 열판이 내장되어 있는 가방을 끝까지 밀어 단자 센서가 인덕션 히터기에 닿도록 올려놓습니다. (빨간색 램프는 충전을 나타냅니다.)
2. 3개의 센서 램프가 알람 소리와 함께 깜빡이면, 가방을 다시 재위치에 놓습니다.
3. 약 2분 30초 후, 녹색 READY 램프가 켜지면, 배달가방이 완전히 충전되었음을 나타냅니다.

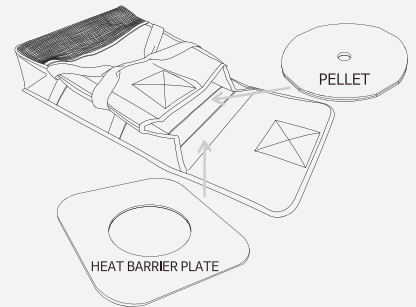

Dimensions

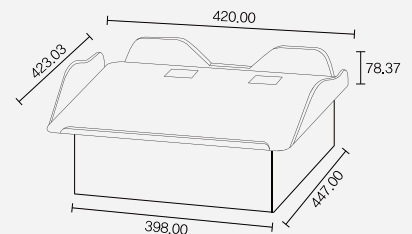
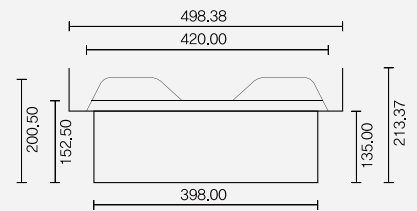

고객사 소개

(주) 에이치디앤텍 고객사

최고의 품질과 신뢰를 바탕으로 고객만족을 실현합니다.

- 피자 브랜드

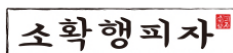

● 치킨 브랜드



● 카페 브랜드



Gong cha



● 기타 브랜드



(2022. 12 월 기준)



Korea Head Office

Add : 서울특별시 성동구 연무장 5 길 18(성수동 2 가) 에이치디앤텍빌딩 (04782)
Tel : (02) 3409. 1181 Fax : (02) 3409. 1186 Email : jongyeol@hdntek.co.kr

China Branch Office (Shanghai Hyupdong Co., Ltd)

Add : 8, Baosheng-road, Songjiang Industrial District, Shanghai, China
Tel : +86. 21. 5781. 0313 Fax : +86. 21. 5781. 7537 Email : sujong@hdntek.com

www.hdntek.com