

CATALOG

종합 카다로그



*PACKAGING &
PIZZA SMALLWARES & EQUIPMENT*

www.hdntek.co.kr

About HD&TEK

고객 여러분 안녕하십니까?

저희 (주)에이치디앤텍은 고객 여러분의 성원을 바탕으로 "고객 만족을 통한 기업 가치 증대"라는 비전을 달성하기 위해 최선의 노력을 다하겠습니다.

(주)에이치디앤텍은 1974년 설립되어 지난 45여 년 동안 국내 외식 산업과 더불어 관련 분야를 선도해왔습니다. 창의적인 기술과 아이디어로 끊임없는 연구개발을 통해 해외 50여 개국 수출이라는 성과를 이뤄내기도 했습니다.

요즘과 같이 빠르게 변화하는 트렌드와 고객의 니즈를 충족시키기 위해 전 임직원들은 최선의 노력을 다하고 있습니다.

우리가 흘린 땀 한 방울이 바로 고객의 만족이 된다는 것을 가슴속 깊이 새겨, "고객 만족을 통한 기업가치 증대"라는 비전을 달성하기 위해 저력과 기술력 그리고 풍부한 노하우를 통해 업계를 선도하는 글로벌 기업으로 거듭날 것을 약속드립니다.

항상 변함없는 관심과 성원 부탁드립니다.

대표이사 *권침인*



● HISTORY

1970 ~

1974.04 협동사 창업

1980 ~

1983.05 의류업체 미국 GAP社에 의류 포장용 BOX 공급

1983.05 한국 피자헛(주) 패키지제품 공급

1990 ~

1992.03 미국 YUM社로부터 Pizza smallware 승인 획득

1994.01 협동조합산업으로 사명 변경

1997.11 한국 피자헛(주) 최우수 협력업체상 수상

1999.04 근흥종합식품(주) 창업

2000 ~

2000.03 미국 YUM社 우수협력업체상 수상

2000.05 품질경영시스템 인증 ISO 9001:2008

2000.11 한국 피자헛(주) 최우수 협력업체상 수상

2000.12 유망 중소기업 선정(신한은행)

2001.07 ISO 9001 인증 획득

2001.09 미국 YUM社 우수협력업체상 수상(2003, 2004)

2001.11 파주 사출공장 준공

2002.04 인덕션히터(Delivery Heating System) 출시(국내특허)

2006.11

한국 피자헛(주) 최우수 협력업체상 수상

2007.

전세계 PizzaHut(55 개국) 수출

2007.11

제 44 회 무역의날 수출탑 수상(산업지원부장관)

2008.03

제 42 회 납세자의 날 표창(국무총리)

CONTENTS

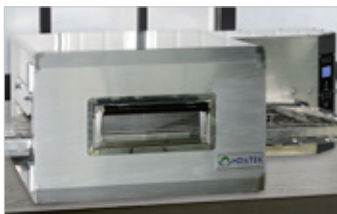

HD&TEK 설비안내	01	에이치디앤티크 본사
	02	김포 1 공장, 김포 2 공장
	03	김포 3 공장, 파주공장, 평택물류센터
패키징	05	패키징 포트폴리오
피자주방용품	09	Pizza Pans / Screens / Separators / Rings
	16	Frying Pans / Cutting Boards / Serving Boards / Cork Mats
	17	Miscellaneous Smallwares
	20	Dough Preparation
	21	Pizza Preparation
	22	For Delivery
	23	Tablewares
	25	Food Pans
커피용품	27	커피용품 포트폴리오
위생용품	30	마스크, 장갑, 헤어캡
주방장비	31	주방장비 포트폴리오
	36	Hot Bag System

2010 ~

2010.01	중국 상해법인 설립	2015.05	기술혁신형 중소기업 (INNO-BIZ) 인증	2016.12	기술평가 우수기업 인증
2010.10	(주)에이치디앤티크 (HD&TEK) 으로 사명 변경	2015.08	김포 패키지 제 2 공장 준공	2018.10	김포 제 3 공장 준공
2012.07	ISO14001 환경경영체제 인증 획득	2015.12	제 52 회 무역의날 수출탑 수상 (대통령상)		
2012.10	김포 패키지 공장 준공	2016.03	FSC 인증		
2014.03	제 48 회 납세자의 날 표창 (부총리상 수상)				
2014.09	벤처기업 인증				
2015.04	환경경영시스템인증서 ISO 14001:2004				

HD&TEK

설비안내

에이치디애펙 본사
 김포 1 공장 · 김포 2 공장 · 김포 3 공장
 파주공장 · 평택물류센터

■ 에이치디애펙 본사

주소	서울특별시 성동구 연무장 5 길 18 에이치디애펙 빌딩 / (우) 04782
대표전화	02) 3409-1181
Fax	02) 3409-1186
주요업무	고객 상담 및 제품개발, 영업, 물류, 유통까지의 업무 제반 사항에 대한 총괄 관리



본사



샘플실

■ 김포 1 공장 (패키징 제품 생산부)

주소	경기도 김포시 양촌읍 황금 2 로 72 김포 학운 1 산업 단지 / (우) 10047
대표전화	031) 983-4754
Fax	031) 983-4701
대 지	1,200 평
주요업무	<ul style="list-style-type: none"> - 각종 종이 패키징 박스 및 쇼핑백 생산 - 각종 식품 포장용 박스 및 칼라 박스, 카톤 박스, 쇼핑백 등 종이 패키징 제품 및 친환경 포장 용기 생산 - 최신식 생산 설비 및 자동화 생산 시스템 구축



김포 1 공장



옵셋인쇄기



자동 톰슨기 1, 2 호기



습수여과살균시스템



자동 접착기 (1면 ~ 6면)



자동합지기 1 호기



재단기

■ 김포 2 공장 (패키징 제품 생산부)

주소	경기도 김포시 양촌읍 학운산단 2 로 73 김포 학운 2 산업 단지 / (우) 10049
대표전화	031) 983-4754
Fax	031) 983-4701
대 지	1,500 평
주요업무	<ul style="list-style-type: none"> - 카톤 박스, 쇼핑백, 선물포장박스 등 각종 패키지 관련 제품들을 다양하게 생산하기 위해 최신 설비와 생산 시스템이 구축되어 있습니다.



김포 2 공장



자동톰슨기 1 호기, 2 호기 (ASAHI)



자동합지기 2 호기



접착기 4 대 (컵홀더전용)



트레이 접착기 2 대

Product Lines

■ 김포 3 공장 (금 / 은지 증착)

주소	경기도 김포시 양촌읍 학운산단 2 로 70 / (우)10047
대표전화	031) 983-4754
Fax	031) 983-4701
주요업무	- 금, 은지 증착, 롤 재단

■ 파주공장 (금속 / 플라스틱 제품 생산부)

주소	경기도 파주시 조리읍 장곡로 91 / (우)10940
대표전화	031) 942-1019
Fax	031) 947-1174
대 지	1,000 평
주요업무	- 각종 금속 및 플라스틱 키친 스몰 웨어, 기계 설비류 생산 - 각종 플라스틱 사출 제품 및 금속 프레스, 다이캐스팅 제품 생산 - 자체 금형 개발 (설계 및 제작) 가능, 최신 자동화 설비 구비

● 플라스틱 사출설비



파주공장



Injection Machine 1 호기 330Tons



Injection Machine 2 호기 300Tons



Injection Machine 3 호기 220Tons



Injection Machine 4 호기 170Tons



Injection Machine 5 호기 170Tons



Laser Machine (레이저)



Offset Machine (절곡기)

● 금속 가공 설비



Pressure Machine 1, 2 호기
200Tons (유압프레스)



Pressure Machine 3 호기
160Tons (유압프레스)



Rivet Press Machine
(리벳프레스)

■ 평택 (물류센터)

주소	경기도 평택시 진위면 경기대로 1713-63 / (우)17706
대표전화	031) 662-4754
Fax	031) 611-4754
대지	7,000 평
주요업무	- 선진화된 재고관리 시스템과 자동화 입출고 시스템 적용을 통한 물류 효율성 및 정확성 극대화 - 자체 배송 차량 보유



평택 물류센터

식품포장박스 전문! 패키징

식품포장 전문! 패키지 기획부터 개발까지, 트렌드와 고객의 니즈를 만족시키는 패키징 전문 회사입니다.



패스트푸드 패키징



피자헛



미스터피자



돈치킨



순수치킨



피자샵



피자알볼로



영구스피자



빨간모자피자



강정구의 피자생각

 <p>간부치킨</p>	 <p>피자몰</p>	 <p>치킨 678</p>	 <p>또봉이통닭</p>
 <p>호치킨</p>	 <p>치피떡</p>	 <p>푸라닭</p>	 <p>KFC</p>
 <p>치킨플러스</p>	 <p>가마로강정</p>	 <p>안심치킨</p>	 <p>브라보피자</p>

카페 패키징

 <p>스타벅스</p>	 <p>할리스</p>		
 <p>이디야커피</p>	 <p>백다방</p>	 <p>주시</p>	 <p>커피빈</p>







Packaging

			
디저트 39	타르타르	커피그루나루	신세계푸드
			
마노핀	카페두다트	탐앤탐스	음료, 브런치 캐리어
			
노보텔 엠베서더	미국 CK PACK 파이	이마트	이노노니주스

식품 패키징

			
본죽	코코호도	신세계푸드	종근당
			
BBQ	송추가마골	청담초밥	꿀밤떡볶이 김밥
			
원할머니보쌈	바사카니	이마트	삼양사





제품 패키징

 <p>SK 하이닉스</p>	 <p>헤라</p>	 <p>컷코</p>
 <p>행텐</p>	 <p>바세린</p>	 <p>삼성</p>

기타 패키징

 <p>비닐봉투</p>	 <p>종이컵, 컵홀더</p>	 <p>카톤박스</p>	 <p>쇼핑백</p>	
 <p>종이봉투</p>	 <p>트레이</p>	 <p>유산지</p>	 <p>엠보싱지</p>	 <p>포장 리본</p>

카렌다

 <p>탁상용</p>	 <p>조립형</p>
 <p>다이어리</p>	 <p>벽걸이</p>

음식의 조리방법을 고려한 **피자주방용품**

축적된 기술과 노하우를 바탕으로,
고객이 만족할 때까지 끊임없는 연구와
노력을 기울이고 있습니다.



Pizza Pans / Screens / Separators / Rings



■ Deep Dish Pans, Black Hard Anodized

ITEM NO.	SIZE	PACKING
12005001	6"	12/Case
12005031	7"	12/Case
12005005	7.5"	12/Case
12005007	9"	12/Case
12005008	10"	12/Case
12005010	10.5"	12/Case
12005012	11"	12/Case
12005014	12"	12/Case
12005016	13"	12/Case
12005018	14"	12/Case
12005020	15"	12/Case



■ Deep Dish Pan Separators, White

ITEM NO.	SIZE	PACKING
12037001	6"	24/Case
12037004	7.5"	24/Case
12037006	9"	24/Case
12037007	10"	24/Case
12037009	10.5"	24/Case
12037011	11"	24/Case
12037013	12"	24/Case
12037015	13"	24/Case
12037019	14"	24/Case
12037021	15"	24/Case



■ Deep Dish Pan Rings, White

ITEM NO.	SIZE	PACKING
12039005	6"	24/Case
12039006	7.5"	24/Case
12039007	9"	24/Case
12007000	10"	24/Case
12039008	10.5"	24/Case
12039009	11"	24/Case
12039010	12"	24/Case
12039011	13"	24/Case
12039012	14"	24/Case
12039013	15"	24/Case

Pizza Pans / Screens / Separators / Rings



■ Perforated Pans, Silver Anodized

ITEM NO.	SIZE	PACKING
12017026	4.5"	24/Case
12017000	6"	24/Case
12017001	7.5"	24/Case
12017002	9"	24/Case
12017003	10"	24/Case
12017004	10.5"	24/Case
12017006	11"	24/Case
12017007	12"	24/Case
12017008	13"	24/Case
12017010	14"	24/Case
12017012	15"	24/Case
12017013	16"	24/Case



■ Perforated Pan Separators, Elevated, White

ITEM NO.	SIZE	PACKING
12037026	6"	12/Case
12037028	7.5"	12/Case
12037030	9"	12/Case
12037033	10"	12/Case
12037036	10.5"	12/Case
12037039	11"	12/Case
12037041	12"	12/Case
12037045	13"	12/Case
12037048	14"	12/Case
12037051	15"	12/Case
12037052	16"	12/Case

■ Perforated Pan Rings, Burgundy / White

ITEM NO.	SIZE	PACKING
12039005	6"	24/Case
12039015	9"	24/Case
12039016	10"	24/Case
12039017	10.5"	24/Case
12039018	11"	24/Case
12039019	12"	24/Case
12039020	13"	24/Case
12039021	14"	24/Case
12039022	16"	24/Case

Pizza Pans / Screens / Separators / Rings

■ Square Perforated Pans, Silver Anodized

ITEM NO.	SIZE	PACKING
12017019	9" x 9"	24/Case
12017020	11" x 11"	24/Case
12017021	12" x 12"	24/Case
12017022	13.5" x 13.5"	24/Case

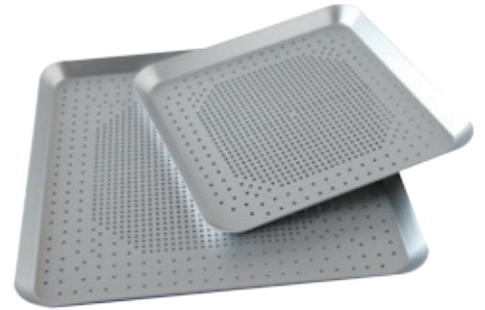

■ Square Perforated Pan Separators, Elevated, White

ITEM NO.	SIZE	PACKING
12037054	9" x 9"	12/Case
12037057	11" x 11"	12/Case
12037059	12" x 12"	12/Case
12037060	13.5" x 13.5"	12/Case



■ Square Perforated Pan Rings, White

ITEM NO.	SIZE	DESCRIPTION	PACKING
12039001	9" x 9"	Used for EDGE Pizza	24/Case
12039002	12" x 12"	Used for EDGE Pizza	24/Case
12039003	13.5" x 13.5"	Used for EDGE Pizza	24/Case



Pizza Pans / Screens / Separators / Rings

■ Sicilian Pan (Breadstick Pan), Black Hard Anodized

ITEM NO.	SIZE	PACKING
12015001	9"x13"	12/Case



■ Sicilian Pan Separator, White

ITEM NO.	SIZE	PACKING
12037023	9"x13"	12/Case



■ Sicilian Pan Ring, White

ITEM NO.	SIZE	PACKING
12039004	9"x13"	12/Case



■ More for all Topping Ring

ITEM NO.	SIZE	PACKING
12039034	9"x13"	12/Case



■ Square Deep Dish Pizza Pan, Black Hard Anodized

ITEM NO.	SIZE	PACKING
12005022	9" x 9"	12/Case



Pizza Pans / Screens / Separators / Rings

■ Square Deep Dish Pizza Pan Separator, White

ITEM NO.	SIZE	PACKING
12037053	9" x 9"	12/Case

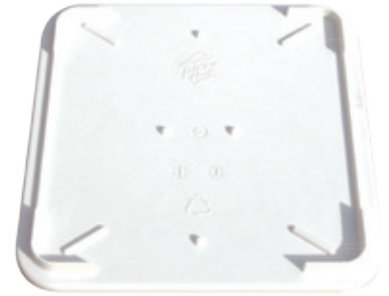

■ Square Deep Dish Pizza Pan Ring, White

ITEM NO.	SIZE	PACKING
12039000	9" x 9"	12/Case



■ Rectangular Pan, Silver Anodized

ITEM NO.	SIZE	PACKING
12004004	12" x 4"	24/Case



■ Rectangular Perforated Pan, Silver Anodized

ITEM NO.	SIZE	PACKING
12017036	260 x 140mm	24/Case



■ Rectangular Perforated Pan Separator, Transparent

ITEM NO.	SIZE	PACKING
12037072	270 x 150mm	12/Case



Pizza Pans / Screens / Separators / Rings



■ Pizza Screens, Black Hard Anodized

ITEM NO.	SIZE	PACKING
12022000	6"	25/Case
12022001	7"	25/Case
12022003	8"	25/Case
12022004	9"	25/Case
12022005	10"	25/Case
12022006	11"	25/Case
12022007	12"	25/Case
12022009	12.6"	25/Case
12022010	13"	25/Case
12022012	14"	25/Case
12022013	15"	25/Case
12022014	16"	25/Case
12022015	17"	25/Case
12022016	18"	25/Case



■ Topping Rings

ITEM NO.	SIZE
13027029	9"(200mm)
13027030	10"(220mm)
13027031	11"(255mm)
13027034	12"(285mm)
13027035	13"(305mm)
13027037	15"(355mm)
13027039	18"(430mm)

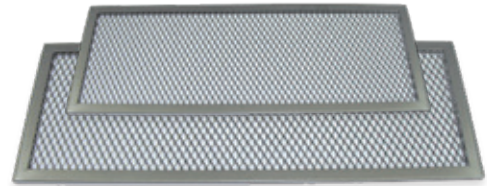

■ Garlic Bread Screens

ITEM NO.	SIZE	PACKING
12022021	311 x 120mm	25/Case
12022023	360 x 120mm	25/Case



■ Pizza Disks

ITEM NO.	SIZE	PACKING
12017033	9"	25/Case
12017014	10"	25/Case
12017015	13"	25/Case
12071000	15"	25/Case
12017017	18"	25/Case

Custom sizes are available.



■ Square Pizza Screens, Black Hard Anodized

ITEM NO.	SIZE	PACKING
12022018	11.5" x 11.5"	25/Case
12022019	14" x 14"	25/Case



■ Thin Pans (Non-perforated), Silver Anodized

ITEM NO.	SIZE	PACKING
12016002	7.5"	24/Case
12016005	9"	24/Case
12016006	10"	24/Case
12016007	10.5"	24/Case
12016009	12"	24/Case
12016012	13"	24/Case
12016016	14"	24/Case
12016013	15"	24/Case

Frying Pans / Cutting Boards / Serving Boards / Cork Mats

■ Frying Pans

ITEM NO.	SIZE
13085015	26cm
13085013	28cm

Induction, Non-Stick Coating.



■ Cutting Boards, Square, No Handle

ITEM NO.	SIZE
13031000	16"x16"
13031001	18"x18"
13031002	19.25"x19.25"
13031003	20"x20"



■ Serving Boards, Round, 5" Handle

ITEM NO.	SIZE
13031004	7"
13031020	8"
13031005	9"
13031006	10"
13031007	11"
13031008	12"
13031009	13"
13031010	14"
13031011	16"
13031012	18"
13031013	20"



WoodFiber Laminate Cutting Boards and Serving Boards have non-porous surface that can be washed in hot, soapy water and will resist warping.

Custom designs and sizes are available.



■ Cork Mats

ITEM NO.	SIZE	SIZE
13071008	428mm	10/Case
13071006	383mm	10/Case
13071005	355mm	10/Case
13071003	268mm	10/Case
13071002	255mm	10/Case
13071000	205mm	10/Case

Custom designs and sizes are available.



Miscellaneous Smallwares

■ Pizza Server, Stainless Steel

ITEM NO.
13083001



■ Squeeze Bottle

ITEM NO.	CAPACITY
13030001	24 oz



■ Check Minders with Ball Bearing

ITEM NO.	SIZE
13050000	457mm
13050001	600mm
13050002	760mm
13050003	900mm
13050004	1200mm

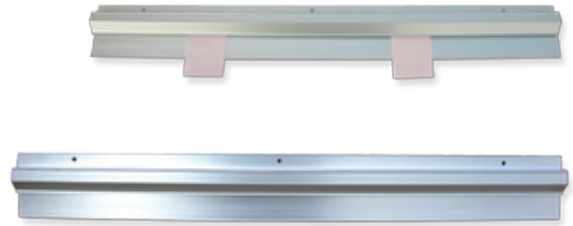

Made of anodized aluminium that holds up to years of service.
They are heat resistant, so they can be mounted above the work area for your convenience.
The racks have the plastic end caps with screws to hold the marbles in.
Custom sizes are available.

■ Thermometers, Pocket

ITEM NO.	RANGE
13054004	0 to 220°F, -10 to 100°C
13054003	- 10 to 100°C
13054002	-40 to 70°C



Recalibration Nut. Plastic watertight lens.
Stainless steel construction.

■ Sauce Spoon, Stainless Steel

ITEM NO.
13047005



■ Salad Crocks



ITEM NO.	CAPACITY	HEIGHT	TOP DIAMETER
12053000	1.4L	4 3/8"	6 3/4"
12053001	2.5L	6 7/8"	6 3/4"

■ 이유식 용기



Available in traditional and designer colors and with snap-tight lids for convenient storage.

Salad Tongs / Spoon

Made of revolutionary plastic material for unbreakable strength and longevity.

ITEM NO.	LENGTH
12048000	8.5" / Tong
12048001	12" / Tong

ITEM NO.	LENGTH
12044000	10" / Spoon



Can Openers

ITEM NO.	DESCRIPITON
13065006	Can Opener, #3
13065002	Portable Can Opener



Pizza Pan Rack

ITEM NO.
13023000

Store your premade pizzas ready to be prepared in the oven. It clears up work area for a faster, more efficient operation. 70 cm high.



Salad Bowls / Rack

ITEM NO.
13023002



Pizza Screen Rack

ITEM NO.
13023001

Holds up to 80 screens from the smallest 6" to 18". Takes up only 9"x14" of table space and stands 10.5" high.

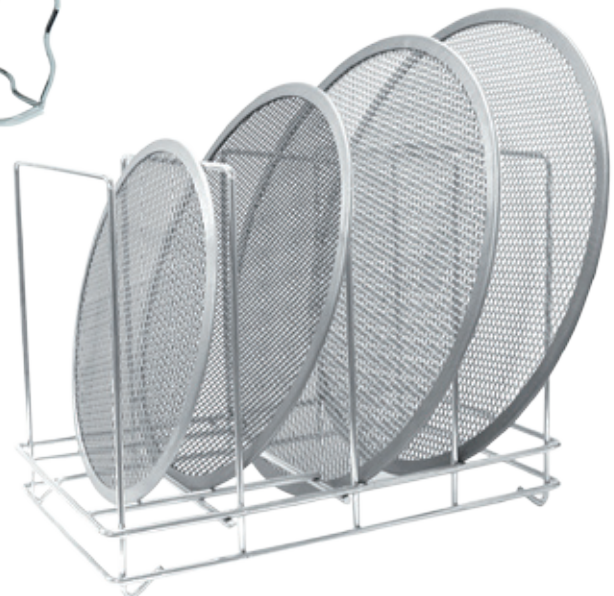

Miscellaneous Smallwares

■ Pizza Shovels, Wood Handle

ITEM NO.	BLADE SIZE	OVERALL
12019000	12"	28"
12019001	14"	28"
12021003	12"	48"
12021004	14"	48"
12019003	12"	35"



■ Pizza Bubble Poppers

ITEM NO.	OVERALL
13006001	39"
13006000	53"



■ Rubber Scraper

ITEM NO.	
13060001	16-1/2" Length. Dishwasher safe.



■ Chicken Wing Grills

ITEM NO.	SIZE
13056000	140mm
13056002	200mm
13056004	280mm
13056005	300mm

Made of stainless steel.
Used to grill chicken wings inside deep dish pans.



■ Heat Pin

ITEM NO.	PACKING
13117000	36/Case

Heavy weight aluminum for maximum heat transfer.

Place the heat pin in the center of pizza and lasagna.
Heat pin delivers heat to the center of the pizza for a faster and more even bake on deep dish and stuffed pizzas.
Dupont Teflon non stick coated.

*Heat Pins should be cleaned after each use. Never scour, just wipe clean with soft cloth.





■ Dough Trays

ITEM NO.	COLOR	SIZE
13114000	Gray	660*455*80mm
13114003	Red	650*450*80mm
13114005	Yellow	650*450*80mm

Dough trays nest together for a tight fit, increasing the quality and storage life of dough. Trays stack at a 90° angle to allow for maximum air circulation during dough proofing.



■ Dough Tray Lids

ITEM NO.	COLOR	SIZE
13114017	Gray	650*450*40mm
13114009	Red	650*450*40mm
13114011	Yellow	650*450*40mm



■ Dough Tray Dolly, Black Steel

ITEM NO.
13079000



■ Dough Tray Dolly With Handle, Stainless Steel

ITEM NO.
13079001



■ Dough Scraper

ITEM NO.	COLOR
12047000	White

The rounded corner cleans the dough tray without excessive scratching or marking.



■ Water Jars

ITEM NO.	CAPACITY
13069091	250cc
13069054	500cc
13069092	1000cc
13069093	2000cc
13069094	4000cc



Pizza Preparation

Rocking Knife / Rocking Knife Base

13064004

517mm length

13064018

Holds rocking knife.



In Pan Cutter

13064019

6", Used for personal pan pizzas.

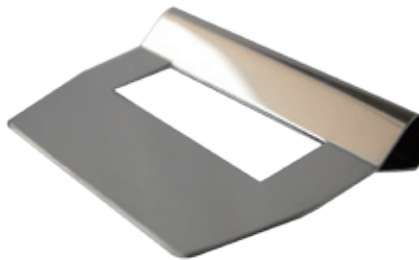

Cutting Wheels

ITEM NO.	WHEEL SIZE
13064000	4"
13064001	5"

Heavy duty one piece molded plastic handles, sanitary stainless steel wheels



Notched Cutting Wheel

ITEM NO.	WHEEL SIZE
13064002	2.7"



Volcano Cutting Wheel

ITEM NO.	WHEEL SIZE
13064003	2.9"/2.6"



Dough Perforator

12035001

12035000

Small size

5" overall length. Use to aerate dough.



Dough Trimmer (Rolling Tool)

12034000

Used to remove excess dough from pan edge.



Pan Gripper

13061000

Cast aluminum alloy with elastomeric spring.



Pizza Servers

ITEM NO.	PACKING	SIZE
13083000	100/Case	2" x 4" blade
13083004	100/Case	2.7" x 8" blade





a



b



c



d



e

a Soft Drink Bags

13095001 Large Size
13095002 Small Size

b Delivery Pouches

33001087 Delivery Bag (Chicken)
33001088 Delivery Bag (Drink)
33001090 Delivery Bag (Pizza)

c Salad Containers for Delivery and To-go

Custom designs and sizes are available.

d Lid Supports

13034000 2000 / Case
Prevents delivery box from crushing pizza.

e Plastic Fork, Spoons

DEL-FRK-000 1000 / case

Tablewares

■ Pizza Stands

ITEM NO.	DESCRIPTION
13038007	Circle
13038009	Square



■ Tumblers

ITEM NO.	DESCRIPTION
12051020	Red 12OZ
12051031	Red 16OZ
12051021	Clear 12OZ
12051036	Clear 22OZ



■ Table Menu Stands

12038001



■ Condiment Holder

13023003



■ Cutlery

ITEM NO.	DESCRIPTION
13081004	Dinner Fork
13012000	Dinner Knife
13047021	Dinner Spoon



■ Cola Pitcher, 1700cc

ITEM NO. _____

12051041

Made of virtually unbreakable polycarbonate.
Lightweight for easy handling.



■ Chicken Baskets

ITEM NO. _____

COLOR or Material _____

13038006

Stainless Steel

12071100

Black

12071101

Yellow



■ Garlic Bread Baskets

ITEM NO. _____

13038000



■ Organizer Rack With Bins

ITEM NO. _____

12055SET

Rack with 6 bins 18"x17"x9-5/8"



■ Non Slip Serving Trays

ITEM NO. _____

SIZE _____

13078002

14" (357mm) Round

13078020

616" (407mm) Round

13078013

14" x 18" (350 x 447mm) Square





Regular Steam Table Pans

	PAN SIZE AND DIMENSIONS	ITEM NO.	DESCRIPTION	PACKING
	Full (1/1) Size Pan 20-3/4"x12-3/4" (530x325mm)	13029032	1.2"(32mm)DEEP	12/Case
		13029033	2.5"(65mm)DEEP	12/Case
		13029034	4.0"(100mm)DEEP	12/Case
		13029035	6.0"(150mm)DEEP	12/Case
		13029036	8.0"(200mm)DEEP	12/Case
	Two Third (2/3) Size Pan 13-7/8"x12-3/4" (354x325mm)	13029039	2.5"(65mm)DEEP	24/Case
		13029040	4.0"(65mm)DEEP	24/Case
		13029041	6.0"(100mm)DEEP	12/Case
		13029042	8.0"(150mm)DEEP	12/Case
	One Half (1/2) Size Pan 12-3/4"x10-3/8" (325x265mm)	13029045	1.2"(32mm)DEEP	24/Case
		13029046	2.5"(65mm)DEEP	24/Case
		13029047	4.0"(100mm)DEEP	24/Case
		13029048	6.0"(150mm)DEEP	12/Case
		13029049	8.0"(200mm)DEEP	12/Case
	One Third (1/3) Size Pan 12-3/4"x6-7/8" (325x176mm)	13029052	2.5"(65mm)DEEP	48/Case
		13029053	4.0"(100mm)DEEP	24/Case
		13029054	6.0"(150mm)DEEP	24/Case
	One Quarter (1/4) Size Pan 10-3/8"x6-3/8" (265x162mm)	13029057	2.5"(65mm)DEEP	72/Case
		13029058	4.0"(100mm)DEEP	48/Case
		13029059	6.0"(150mm)DEEP	48/Case
	One Sixth (1/6) Size Pan 6-7/8"x6-1/4" (176x162mm)	13029062	2.5"(65mm)DEEP	72/Case
		13029063	4.0"(100mm)DEEP	48/Case
		13029064	6.0"(150mm)DEEP	48/Case
	One Ninth (1/9) Size Pan 6-7/8"x4-1/4" (176x108mm)	13029067	2.5"(65mm)DEEP	72/Case
		13029068	4.0"(100mm)DEEP	72/Case

Covers

	PAN SIZE	SOLID COVERS	PACKING	SLOTTED COVERS	PACKING
	1/1 Size Coverage	13029037	24 / case	13029038	24 / case
	2/3 Size Coverage	13029043	24 / case	13029044	24 / case
	1/2 Size Coverage	13029050	24 / case	13029051	24 / case
	1/3 Size Coverage	13029055	24 / case	13029056	24 / case
	1/4 Size Coverage	13029060	24 / case	13029061	24 / case
	1/6 Size Coverage	13029065	24 / case	13029066	24 / case
	1/9 Size Coverage	13029069	24 / case	13029070	24 / case



Polycarbonate Food Pans

	PAN SIZE AND DIMENSIONS	ITEM NO.	DESCRIPTION	PACKING
	Full (1/1) Size Pan 20-3/4"x12-3/4" (530x325mm)	13029000	2.5"(65mm)DEEP	12/Case
		13029001	4.0"(100mm)DEEP	12/Case
		13029002	6.0"(150mm)DEEP	12/Case
		13029003	8.0"(200mm)DEEP	12/Case
	One Half (1/2) Size Pan 12-3/4"x10-3/8" (325x265mm)	13029006	2.5"(65mm)DEEP	24/Case
		13029007	4.0"(100mm)DEEP	24/Case
		13029008	6.0"(150mm)DEEP	12/Case
		13029009	8.0"(200mm)DEEP	12/Case
	One Third (1/3) Size Pan 12-3/4"x6-7/8" (325x176mm)	13029012	2.5"(65mm)DEEP	24/Case
		13029013	4.0"(65mm)DEEP	24/Case
		13029014	6.0"(100mm)DEEP	24/Case
		13029015	8.0"(150mm)DEEP	12/Case
	One Quarter (1/4) Size Pan 10-3/8"x6-3/8" (265x162mm)	13029018	2.5"(65mm)DEEP	36/Case
		13029019	4.0"(100mm)DEEP	36/Case
		13029020	6.0"(150mm)DEEP	24/Case
	One Sixth (1/6) Size Pan 6-7/8"x6-1/4" (176x162mm)	13029023	2.5"(65mm)DEEP	36/Case
		13029024	4.0"(100mm)DEEP	48/Case
		13029025	6.0"(150mm)DEEP	24/Case
	One Ninth (1/9) Size Pan 6-7/8"x4-1/4" (176x108mm)	13029028	2.5"(65mm)DEEP	72/Case
		13029029	4.0"(100mm)DEEP	72/Case

Covers

	PAN SIZE	SOLID COVERS	PACKING	SLOTTED COVERS	PACKING
	1/1 Size Coverage	13029004	24 / case	13029005	24 / case
	1/2 Size Coverage	13029010	48 / case	13029011	48 / case
	1/3 Size Coverage	13029016	72 / case	13029017	72 / case
	1/4 Size Coverage	13029021	72 / case	13029022	72 / case
	1/6 Size Coverage	13029026	72 / case	13029027	72 / case
	1/9 Size Coverage	13029030	72 / case	13029031	72 / case

커피전문점 어디서나 볼 수 있는 커피용품

컨디먼트바 인서트 부자재, 컵홀더 디스펜서, 머그트리, 블랙플래터, 머들러, 코어스터, 컵홀더, 베이글커터 등 사용자 중심의 디자인을 추구합니다.



■ 나우브루잉 이젤 (NOW BREWING)



■ 내부 홍보물 거치대



■ 계량컵 (Measuring Cup)

ITEM NO.
13078035



■ 머들러 (Muddler)

ITEM NO.
13047017



Coffee smallwares

- 플라스틱컵 (PET Cup & LID)



- 컵홀더 디스펜서 (Cup Holder Dispenser)



- 머그컵 (Mug Cup)



- 컵홀더 (Cup Holder)



- 컵 받침대 (Coaster)



- 머그트리 (Mug Tree)

ITEM NO.
13030003



- 컨디먼트바 인서트 부자재 (Condiment Bar Utensil)



ITEM NO.

DESCRIPTION

13049022	Cup Disposable Container
13049025	Recycle
13049026	Trash
13049027	Liquid

Coffee smallwares

■ 냅킨보관함 (Napkin Dispenser)

ITEM NO. _____
12029000



■ 베이글커터 (Bagel Cutter)

ITEM NO. _____
13066000



■ 초콜릿 케이스



■ 티켓스탠드



■ Candibar



■ 블랙플래터 (Black Platter)

ITEM NO.	SIZE
12059000	(L)
12059002	(M)
12059001	(S)

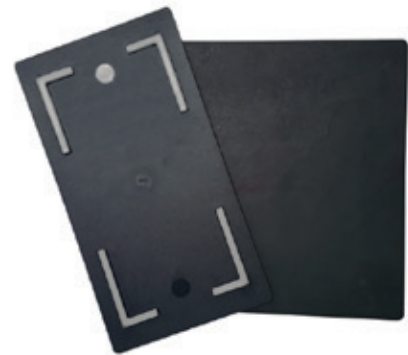

■ 등신대 (Full Size Portrait)



■ 우산 거치대



위생용품

위생장갑, 헤어캡, 마스크는 식당, 연구소, 공장단지 등에서 널리 쓰이고 있습니다.



■ Gloves

ITEM NO.	DESCRIPTION	SIZE
13089000	Ultra Slim Nitrile Powder Free	(S)
13089004	Latex Powder Free Gloves	(M)
13089005	Latex Powder Free Gloves	(L)
13089006	Latex Powdered Gloves	(S)
13089007	Latex Powdered Gloves	(M)
13089008	Latex Powdered Gloves	(L)



■ Hair Caps

ITEM NO.	SIZE
13090001	18"
13090002	21"



■ Mask

ITEM NO.
13088000



독보적인 기술력 외식업소용 주방장비

피자가스오븐, 핫워터 디스펜서, 도우프레스,
블럭치즈분쇄기, 컵워머, 머그랙은 에이치디앤텍만의
기술력이 집약된 제품입니다.



■ Pizza Gas Oven 18"

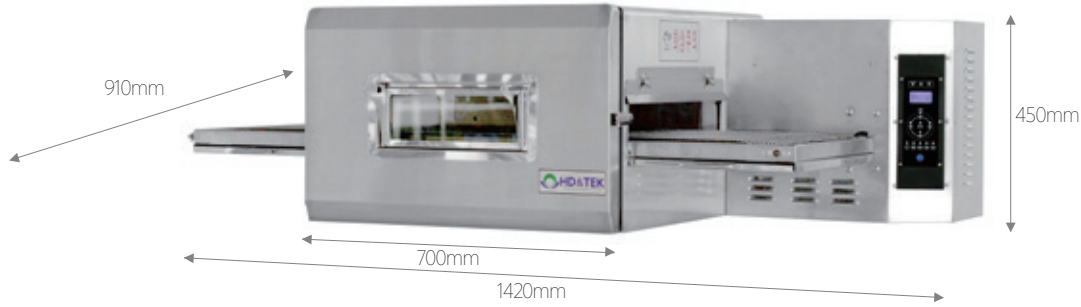

모델명	SY-1800P (LPG) SY-1800N (LNG)	전 원	AC220V, 60Hz, 300W
외형 규격 (WxDxH)	1420 × 910 × 450(mm)	재 질	스테인리스
열 량	LNG : 9,800kal LPG : 0.8kg/h	노즐 규격	LPG(1.4*2EA) LNG(1.9*2EA)
정격 사용온도	250°C~260°C	중 량	120Kg
예열 시간	6 분 50 초	피자팬 최대 규격	21"
냉각 시간	20 분	컨베어 속도	3 분 ~ 25 분

■ Pizza Gas Oven 19.5"

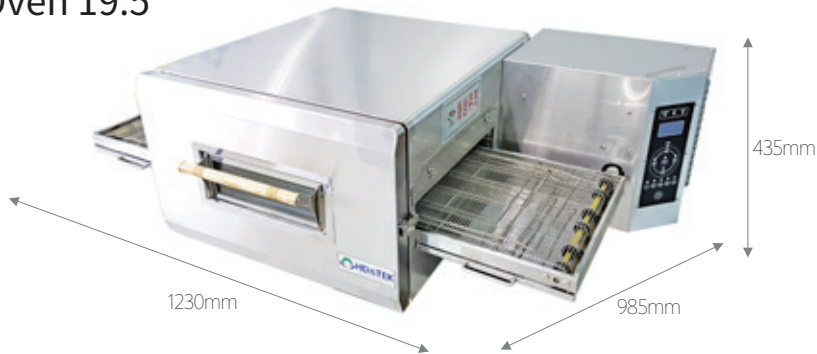

모델명	SY-1950P (LPG) SY-1950N (LNG)	전 원	AC220V, 60Hz, 300W
외형 규격 (WxDxH)	1230 × 985 × 435(mm)	재 질	스테인리스
열 량	LNG : 11,500kal LPG : 0.95kg/h	중 량	116Kg
정격 사용온도	250°C~260°C	피자팬 최대 규격	19.5"
예열 시간	6 분 50 초	컨베어 속도	3 분 ~ 25 분
냉각 시간	20 분		

■ Pizza Gas Oven 21"

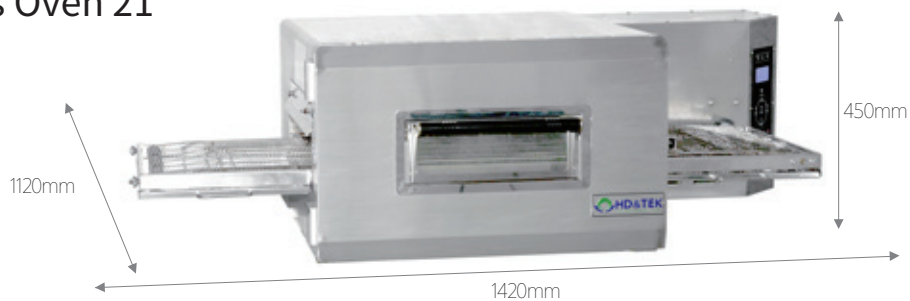

모델명	SY-2100P (LPG) SY-2100N (LNG)	전 원	AC220V, 60Hz, 300W
외형 규격 (WxDxH)	1420 × 1120 × 450(mm)	재 질	스테인리스
열 량	LNG : 12,500kal LPG : 0.97kg/h	노즐 규격	LPG(2*1) LNG(2.8*1)
정격 사용온도	250°C~260°C	중 량	130Kg
예열 시간	6 분 50 초	피자팬 최대 규격	21"
냉각 시간	20 분	컨베어 속도	3 분 ~ 25 분

Equipment

■ 도우프레스 (Dough Press)

전 원	220V
소비전력	400W
제품중량	120Kg
규격 (WxDxH)	600 X 712 X 760(mm)
도우사이즈	최대 14 인치
사용용도	피자 도우를 규격에 맞게 펴는데 사용

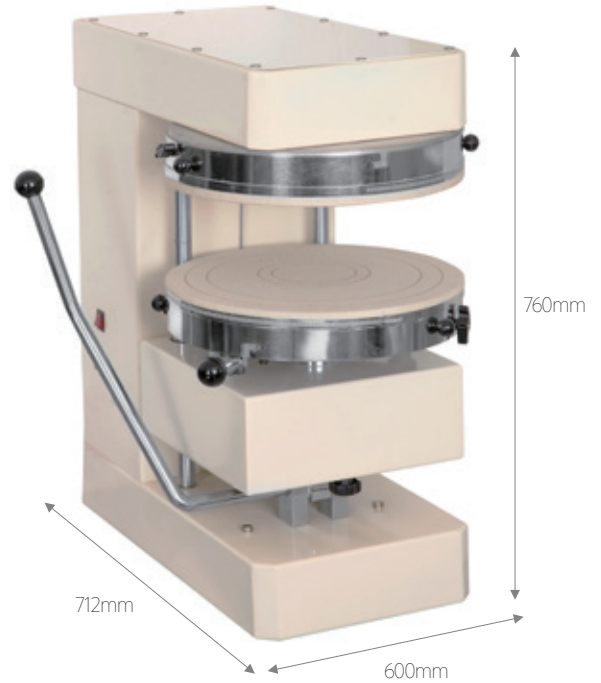

Features

1. 간단한 조작으로 도우를 규격에 맞게 펴주어 사용이 편리합니다.
2. 사용법에 따라 원하는 도우 사이즈를 제작할 수 있습니다.

사용방법

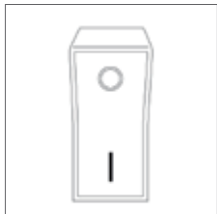

1. 스위치 ON 합니다.



2. 도우가 프레스 상, 하면에 붙지 않도록 프레스 상, 하면에 옥수수 가루를 충분히 뿌려줍니다.



3. 반죽 물에 옥수수 가루를 충분히 묻힌 후 도우프레스 중앙에 투입합니다.

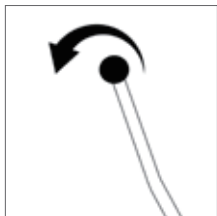

4. 상, 하 손잡이를 당겨서 하강합니다.

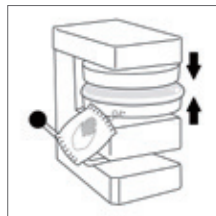

5. 부직포에 반죽 물이 붙지 않게 옥수수 가루를 뿌려주며, 상, 하 손잡이를 하강한 후 두께를 확인합니다.

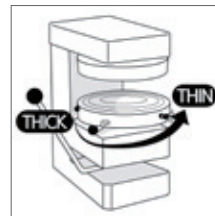

6. 두께가 얇거나 두꺼울 경우 두께 조절 손잡이를 이용, 조절합니다.

※ 시계방향은 두꺼워지며, 반시계 방향은 얇아짐.

■ 블럭 치즈 분쇄기 (Cheese Cutter)

전 원	220V
정격전압	220V, 60hz
정격입력	210W
규격 (WxDxH)	230 X 415 X 515(mm)

Features

1. 전기방식의 치즈 커터기입니다.
2. 스테인리스 구조로 녹이 슬지 않으며, 위생적입니다.
3. 블럭 치즈를 직접 가공하여 슈레드치즈를 제작함으로써 가공비가 절감됩니다.
4. 커터기를 사용함으로써 가공치즈에 비해 저장성이 용이합니다.
5. 치즈 굵기를 조절할 수 있습니다.
6. 소음이 적으며 부드럽게 작동됩니다.



■ 디지털 핫워터 디스펜서 (Digital Hot Water Dispenser)

전 원	220V
정격용량	7L
정격전압	220V
규격 (WxDxH)	305 X 315 X 490(mm)
정격입력	3000W
최초발열시간	설정 사양에 따라 다름 (참고 : 물 온도 97°C 설정 시 약 15 분 소요)



Features

1. 0.1 초 단위의 세팅으로 정확한 물 용량의 취수가 가능합니다.
2. 버튼식으로 되어 있어 작동이 편리합니다.
3. 많은 물을 취수하여도 온도 복원 속도가 빠릅니다. (85°C → 95°C 약 4 분 소요)
4. 자유 급수가 가능합니다.

온도설명 및 사용방법



1. SET 버튼을 약 3초간 누릅니다. (최초 시만 3초간 눌러주세요)

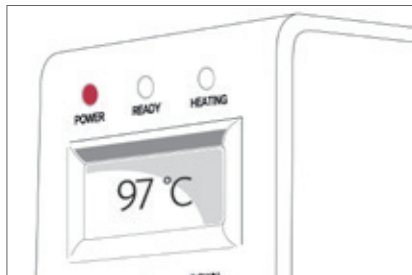

2. 설정온도 숫자가 깜빡거립니다.

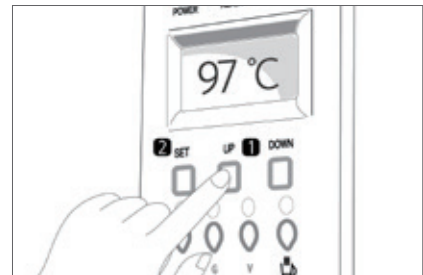

3. "UP", "DOWN" 버튼을 사용하여 원하는 온도를 설정한 후 "SET" 버튼을 누릅니다.

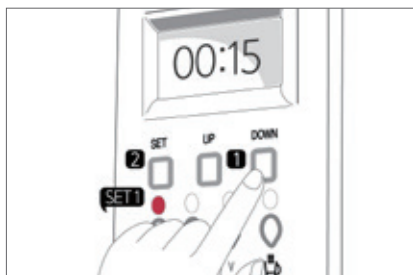

4. 온도 설정 후 "SET1" 이 깜빡거리면 원하는 설정 시간을 조정합니다. 설정 시간 설정 후 "SET" 버튼을 누릅니다.

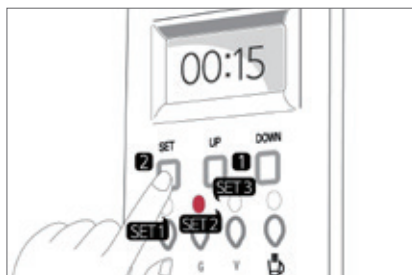

5. 같은 방법으로 "SET 2"와 "SET 3"을 설정합니다.



6. 4번째 버튼을 누르면 연속 취수가 되고, 버튼에서 손을 떼면 취수가 정지됩니다.

Tip 설정 전 원하는 물의 중량을 몇 초로 세팅하면 되는지, 세팅 값을 알아둡니다. (0.1초당 4~4.5ml 취수)

	Small	Regular	Large	X-Large
물 용량 (ml)	207	295	383	471
시간 (SEC)	4.8	6.8	8.8	10.8

Equipment

■ 컵워머 (Cup Warmer, W.Heater)

정격접압	220V, 60Hz, 0.8kW
규격 (WxDxH)	255 X 425 X 550(mm)
컵 개수	36 개 (선반 한 층에 9 잔씩 4 칸)

Features

1. 머그컵을 오랫동안 따뜻하게 데워줍니다.
2. 최대 36 개 컵을 보관할 수 있습니다. (선반 한 층에 9 잔씩 4 칸)
3. 컵의 보온과 일정 온도를 유지함으로써, 커피 맛을 오랫동안 지속하게 합니다.

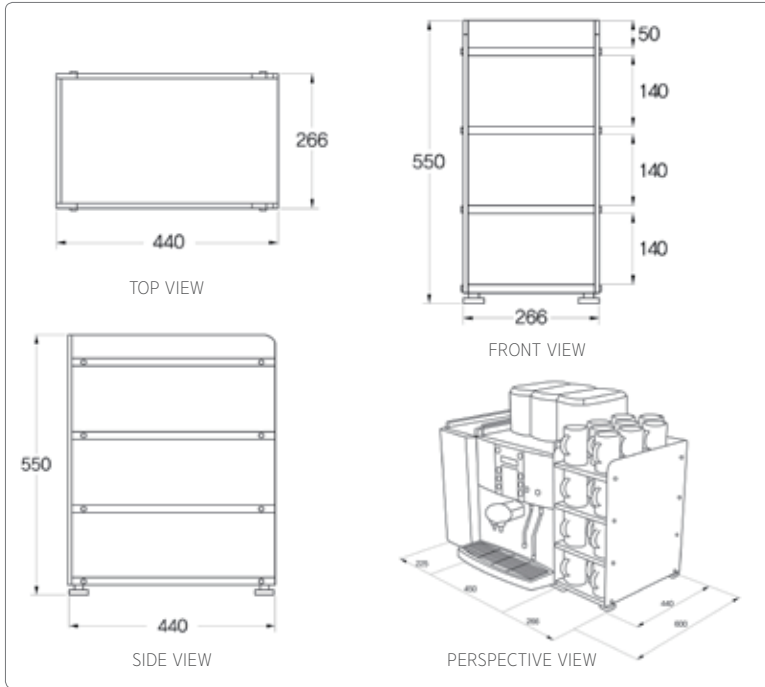

■ 머그랙 보관함 (Mug Rack Storage)

규격 (WxDxH)	430 X 700 X 840(mm)
------------	---------------------

Features

1. 세척한 머그잔을 보관하는 수납장 형태이며 하단에는 물받이가 있습니다.

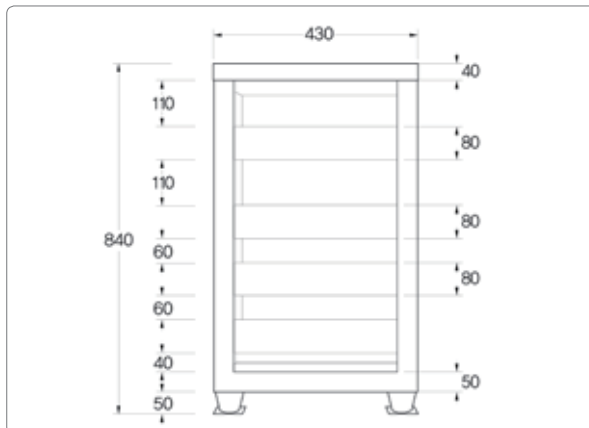

Hot Bank Induction Heating Delivery System

HOT BANK(인덕션 히팅 시스템) 는 피자를 배달할 때 , 히팅기에 의해 가열된 특수 가방에 넣어서 배달함으로써 오븐에서 갓 구워낸 맛 그대로의 따뜻한 피자를 고객에게 배달할 수 있는 시스템입니다. 자체 특허 기술을 통해 개발한 인덕션 히터 및 전용 파우치를 통해 매장 내 사용에 안전성과 간편성을 더하였으며 , 어떠한 환경에서도 피자 의 최적온도 (75℃ ~80℃)를 유지시켜주는 최첨단 고객만족 시스템입니다 .



Delivery Pouches

33001081 Fabric, Black

- * 배달가방은 일반 가방에서 발생하는 습을 제거하는 신솔레이터가 내장되어 있으며, 내구성이 강합니다.
- * 히팅 된 가방 내부 온도는 약 30 분 동안 75℃ ~80℃ 으로 유지되어 항상 갓 구워낸 피자를 맛보실 수 있습니다.



Instruction

1. 특수 열 보존형 열판이 내장되어 있는 가방을 끝까지 밀어 단자 센서가 인덕션 히터기에 닿도록 올려놓습니다. (빨간색 램프는 충전을 나타냅니다.)
2. 3개의 센서 램프가 알람 소리와 함께 깜빡이면, 가방을 다시 재위치에 놓습니다.
3. 약 2분 30초 후, 녹색 READY 램프가 켜지면, 배달가방이 완전히 충전되었음을 나타냅니다.

Induction Heater

32001000 220V

- * 조작이 간편하고 , 유지 보수가 거의 필요하지 않습니다 .
- * 기계 내부에 자가 진단 기능이 있어 문제 발생시 경보음 및 자동 OFF 가 됩니다 .
- * 인덕션 히팅기로서 기계 자체에는 열이 전혀 없으며 , 가볍고 사용이 간편합니다 .
- * 금속 제품은 절대 올리지 마십시오(알루미늄, 스테인리스 제품)

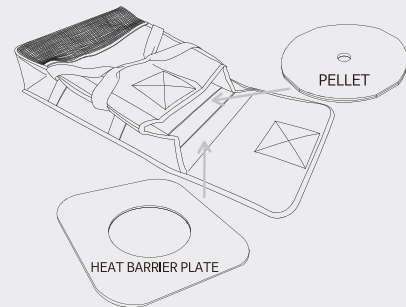

Heating Pellet

33003000 Heating Pellet

- * 특수 강철 소재와 합성수지를 사용해 열을 오랫동안 유지할 수 있으며 , 최대 400℃까지 견딜 수 있도록 제작되어 있습니다. (자동 온도 제어 센서 부착)
- * 특수 제작된 합성수지로, 가열 시 발생하는 냄새가 전혀 없고, 식품에 안전합니다 .



Dimensions

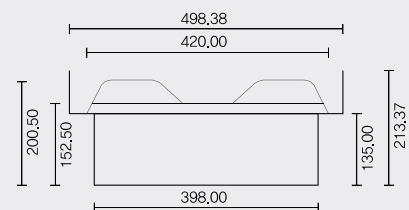

Heat Barrier Plate

- * 열 손실을 방지하는 특수 소재로 제작되었습니다.

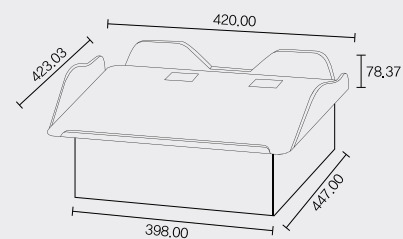



Korea Head Office
 Add : 서울특별시 성동구 연무장 5 길 18(성수동 2가) 에이치디앤텍빌딩 (04782)
 Tel : (02) 3409-1181 Fax : (02) 3409-1186 Email : jongyeol@hdntek.co.kr

China Branch Office (Shanghai Hyupdong Co., Ltd)
 Add : 8, Baosheng-road, Songjiang Industrial District, Shanghai, China
 Tel : 86-21-5781-0313 Fax : 86-21-5781-7537 Email : sujong@hdntek.com

www.hdntek.co.kr



The mark of responsible forestry



ISO 9001



ISO 14001:2004