



**Korea Head Office**  
 Add : HD&TEK Bdg, 18, Yeonmujang 5-gil, Seongdong-gu, Seoul, Korea (133-835)  
 Tel : +82. (0)2. 3409. 1181 Fax : +82. (0)2. 3409. 1186 Email : sujong@hdntek.com

**China Branch Office (Shanghai Hyupdong Co., Ltd)**  
 Add : 8, Baosheng-road, Songjiang Industrial District, Shanghai, China  
 Tel : +86. (0)21. 5781. 0313 Fax : +86. (0)21. 5781. 7537 Email : sujong@hdntek.com

**USA Branch Office (J2 Global Inc)**  
 Add : 1572 Kimberly Ave, Fullerton, CA 92831  
 Tel : +1. 714. 870. 4003 Fax : +1. 714. 870. 4004 Email : sujong@hdntek.com

## Pizza Smallwares 2018 Catalog

[www.hdntek.com](http://www.hdntek.com)

# About HD&TEK

Founded in 1974, **Hyup Dong** started as a manufacturer of paper boxes for domestic and export uses.

In the late 1980s, when the restaurant business started to explode in Korea including pizza outlets, **Hyup Dong** heavily invested in the development of food service smallwares, especially pizza smallwares that were dependent on imports.

**Hyup Dong** has also aggressively invested in developing products that meet the requirements of customers.

The end result is that we are able to supply exceptional quality products to customers at competitive prices with the added benefit of a short turnaround time.

We renamed the company to **HD&TEK** Food Service in 2010.

**HD&TEK** is committed to excellence and customer satisfaction.

We believe that we provide exceptional products.

We always have and will stand behind our products until our clients are satisfied.

**We understand how to work together with  
And we know how to win together with**

**We are a real customer maniac!**

Hot Bank Induction Heating Delivery System .....	01
Pizza Pans / Screens / Separators / Rings .....	03
Frying Pans / Cutting Boards / Serving Boards / Cork Mats .....	10
Dough Preparation .....	11
Pizza Preparation .....	13
Miscellaneous Smallwares .....	15
For Delivery .....	18
Tablewares .....	19
Food Pans .....	21



# Hot Bank Induction Heating Delivery System

## Hot Bank Induction Heating Delivery System

Our new HOT BANK induction heating pizza delivery system allows pizza stores to deliver hot pizzas rights to the customers' doorsteps. HOT BANK heats up the special heating element that is installed inside a special delivery pouch that retains the heat for a prolonged period of time. Now pizzas can be delivered at the ideal temperature of 75 to 80 degrees Celsius to the customers. And it is made of special metal alloy and plastic alloy and made to withstand up to 400 degrees Celsius, too. (Temperature control sensor built in).



### a Delivery Pouches

33001086 Fabric, Black

The Hot Bank pizza pouches are made using 3M™ Thinsulate™ Insulation thermal technology.



### b Induction Heater

32001000 220V



### c Heating Pellet

33003000 Heating Pellet

## Instruction

1. The delivery pouch with the special pellet installed is placed on the induction heater. (The red CHARGE lamp lights up indicating the delivery pouch is charging.)
  - ※ If three SENSOR lamps blink with an alarm sound, remove and reposition the delivery pouch.
2. After about two and half minutes, the green READY lamp will light up indicating that the delivery pouch is fully charged.
  - ※ After the first charge, recharges will take approximately 60 seconds or less, depending on the residual temperature in the pellet.
3. The delivery pouch is ready to use for delivery.

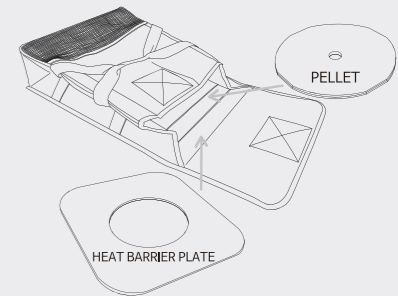

## Dimensions

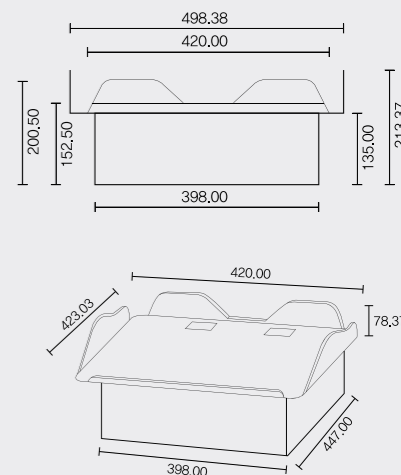

## Pizza Pans / Screens / Separators / Rings



■ Deep Dish Pans, Black Hard Anodized

ITEM NO.	SIZE	PACKING
12005001	6"	12/Case
12005031	7"	12/Case
12005005	7.5"	12/Case
12005007	9"	12/Case
12005008	10"	12/Case
12005010	10.5"	12/Case
12005012	11"	12/Case
12005014	12"	12/Case
12005016	13"	12/Case
12005018	14"	12/Case
12005020	15"	12/Case

## Pizza Pans / Screens / Separators / Rings



■ Perforated Pans, Silver Anodized

ITEM NO.	SIZE	PACKING
12017026	4.5"	24/Case
12017000	6"	24/Case
12017001	7.5"	24/Case
12017002	9"	24/Case
12017003	10"	24/Case
12017004	10.5"	24/Case
12017006	11"	24/Case
12017007	12"	24/Case
12017008	13"	24/Case
12017010	14"	24/Case
12017012	15"	24/Case
12017013	16"	24/Case



■ Deep Dish Pan Separators, White

ITEM NO.	SIZE	PACKING
12037001	6"	24/Case
12037004	7.5"	24/Case
12037006	9"	24/Case
12037007	10"	24/Case
12037009	10.5"	24/Case
12037011	11"	24/Case
12037013	12"	24/Case
12037015	13"	24/Case
12037019	14"	24/Case
12037021	15"	24/Case



■ Deep Dish Pan Rings, White

ITEM NO.	SIZE	PACKING
12039005	6"	24/Case
12039006	7.5"	24/Case
12039007	9"	24/Case
12007000	10"	24/Case
12039008	10.5"	24/Case
12039009	11"	24/Case
12039010	12"	24/Case
12039011	13"	24/Case
12039012	14"	24/Case
12039013	15"	24/Case



■ Perforated Pan Separators, Elevated, White

ITEM NO.	SIZE	PACKING
12037026	6"	12/Case
12037028	7.5"	12/Case
12037030	9"	12/Case
12037033	10"	12/Case
12037036	10.5"	12/Case
12037039	11"	12/Case
12037041	12"	12/Case
12037045	13"	12/Case
12037048	14"	12/Case
12037051	15"	12/Case
12037052	16"	12/Case



■ Perforated Pan Rings, Burgundy / White

ITEM NO.	SIZE	PACKING
12039005	6"	24/Case
12039015	9"	24/Case
12039016	10"	24/Case
12039017	10.5"	24/Case
12039018	11"	24/Case
12039019	12"	24/Case
12039020	13"	24/Case
12039021	14"	24/Case
12039022	16"	24/Case

## Pizza Pans / Screens / Separators / Rings

### ■ Square Perforated Pans, Silver Anodized

ITEM NO.	SIZE	PACKING
12017019	9" x 9"	24/Case
12017020	11" x 11"	24/Case
12017021	12" x 12"	24/Case
12017022	13.5" x 13.5"	24/Case

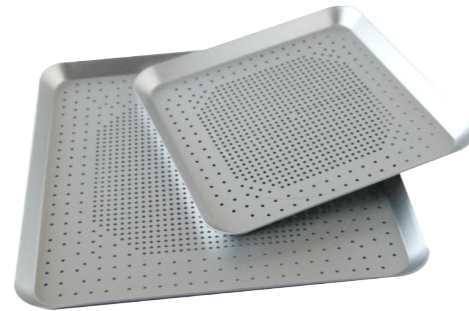

### ■ Square Perforated Pan Separators, Elevated, White

ITEM NO.	SIZE	PACKING
12037054	9" x 9"	12/Case
12037057	11" x 11"	12/Case
12037059	12" x 12"	12/Case
12037060	13.5" x 13.5"	12/Case



### ■ Square Perforated Pan Rings, White

ITEM NO.	SIZE	DESCRIPTION	PACKING
12039001	9" x 9"	Used for EDGE Pizza	24/Case
12039002	12" x 12"	Used for EDGE Pizza	24/Case
12039003	13.5" x 13.5"	Used for EDGE Pizza	24/Case



## Pizza Pans / Screens / Separators / Rings

### ■ Sicilian Pan (Breadstick Pan), Black Hard Anodized

ITEM NO.	SIZE	PACKING
12015001	9"x13"	12/Case



### ■ Sicilian Pan Separator, White

ITEM NO.	SIZE	PACKING
12037023	9"x13"	12/Case



### ■ Sicilian Pan Ring, White

ITEM NO.	SIZE	PACKING
12039004	9"x13"	12/Case



### ■ More for all Topping Ring

ITEM NO.	SIZE	PACKING
12039034	9"x13"	12/Case



### ■ Garlic Bread cover

ITEM NO.	SIZE	PACKING
12003001	9"x13"	12/Case



### ■ Garlic Bread Trivet

ITEM NO.	SIZE	PACKING
12003000	9"x13"	48/Case

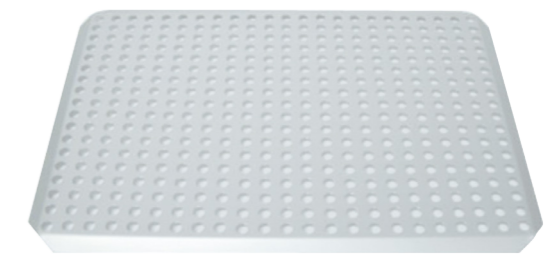

## Pizza Pans / Screens / Separators / Rings

### ■ Square Deep Dish Pizza Pan, Black Hard Anodized

ITEM NO.	SIZE	PACKING
12005022	9" x 9"	12/Case



### ■ Square Deep Dish Pizza Pan Separator, White

ITEM NO.	SIZE	PACKING
12037053	9" x 9"	12/Case



### ■ Square Deep Dish Pizza Pan Ring, White

ITEM NO.	SIZE	PACKING
12039000	9" x 9"	12/Case



### ■ Rectangular Pan, Silver Anodized

ITEM NO.	SIZE	PACKING
12004004	12" x 4"	24/Case



### ■ Rectangular Perforated Pan, Silver Anodized

ITEM NO.	SIZE	PACKING
12017036	260 x 140mm	24/Case



### ■ Rectangular Perforated Pan Separator, Transparent

ITEM NO.	SIZE	PACKING
12037072	270 x 150mm	12/Case



## Pizza Pans / Screens / Separators / Rings

### ■ Pizza Screens, Black Hard Anodized

ITEM NO.	SIZE	PACKING
12022000	6"	25/Case
12022001	7"	25/Case
12022003	8"	25/Case
12022004	9"	25/Case
12022005	10"	25/Case
12022006	11"	25/Case
12022007	12"	25/Case
12022009	12.6"	25/Case
12022010	13"	25/Case
12022012	14"	25/Case
12022013	15"	25/Case
12022014	16"	25/Case
12022015	17"	25/Case
12022016	18"	25/Case



### ■ Topping Rings

ITEM NO.	SIZE
13027029	9"(200mm)
13027030	10"(220mm)
13027031	11"(255mm)
13027034	12"(285mm)
13027035	13"(305mm)
13027037	15"(355mm)
13027039	18"(430mm)



### ■ Square Pizza Screens, Black Hard Anodized

ITEM NO.	SIZE	PACKING
12022018	11.5" x 11.5"	25/Case
12022019	14" x 14"	25/Case

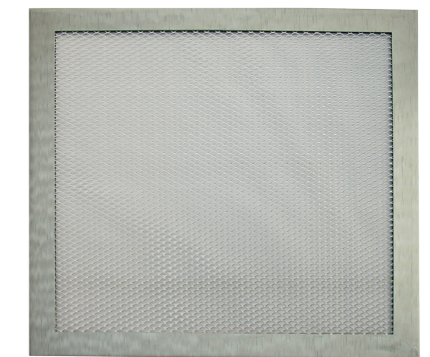

### ■ Garlic Bread Screens

ITEM NO.	SIZE	PACKING
12022021	311 x 120mm	25/Case
12022023	360 x 120mm	25/Case

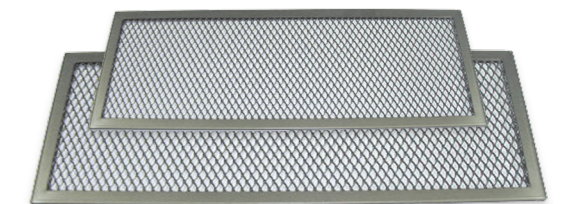

## Pizza Pans / Screens / Separators / Rings

### ■ Thin Pans(Non-perforated), Silver Anodized

ITEM NO.	SIZE	PACKING
12016002	7.5"	24/Case
12016005	9"	24/Case
12016006	10"	24/Case
12016007	10.5"	24/Case
12016009	12"	24/Case
12016012	13"	24/Case
12016016	14"	24/Case
12016013	15"	24/Case



### ■ Pizza Disks

ITEM NO.	SIZE	PACKING
12017033	9"	25/Case
12017014	10"	25/Case
12017015	13"	25/Case
12071000	15"	25/Case
12017017	18"	25/Case

Custom sizes are available.



### ■ Chicago Pizza Ring

ITEM NO.	SIZE	PACKING
12001017	10"	25/Case



Used with Pizza Screens and Disk  
Custom sizes are available.



## Frying Pans / Cutting Boards / Serving Boards / Cork Mats

### ■ Frying Pans

ITEM NO.	SIZE
13085015	26cm
13085013	28cm

It is ceramic coated and can be used on induction range.



### ■ Cutting Boards, Square, No Handle

ITEM NO.	SIZE
13031000	16"x16"
13031001	18"x18"
13031002	19.25"x19.25"
13031003	20"x20"



### ■ Serving Boards, Round, 5" Handle

ITEM NO.	SIZE
13031004	7"
13031020	8"
13031005	9"
13031006	10"
13031007	11"
13031008	12"
13031009	13"
13031010	14"
13031011	16"
13031012	18"
13031013	20"



WoodFiber Laminate Cutting Boards and Serving Boards have non-porous surface that can be washed in hot, soapy water and will resist warping.

Custom designs and sizes are available.



### ■ Cork Mats

ITEM NO.	SIZE	SIZE
13071008	428mm	10/Case
13071006	383mm	10/Case
13071005	355mm	10/Case
13071003	268mm	10/Case
13071002	255mm	10/Case
13071000	205mm	10/Case

Custom designs and sizes are available.



## Dough Preparation



### Dough Trays

ITEM NO.	COLOR	SIZE
13114000	Gray	660*455*80mm
13114003	Red	650*450*80mm
13114005	Yellow	650*450*80mm



### Dough Tray Lids

ITEM NO.	COLOR	SIZE
13114017	Gray	650*450*40mm
13114009	Red	650*450*40mm
13114011	Yellow	650*450*40mm



### Dough Tray Dolly, Black Steel

ITEM NO.
13079000



### Dough Tray Dolly with Handle, Stainless Steel

ITEM NO.
13079001



### Dough Timer

ITEM NO.
12036SET1

8 colors / 10ea (80ea in total)



## Dough Preparation

### Dough Stamper

ITEM NO.	COLOR
12033000	White

6" dough stamp pushes dough down inside 6" pizza pan. Four holes release air to prevent dough from sticking to stamper.



### Dough Scraper

ITEM NO.	COLOR
12047000	White

The rounded corner cleans the dough tray without excessive scratching or marking.



### Oil Jar

ITEM NO.	SIZE
13052000	One gallon(3.78)



### Oil Pumps

ITEM NO.	DELIVERY VOLUME
12045000	7g, Black
12045001	10g, White
12045005	15g, Burgundy
12045004	22g, Blue



### Gap Gauge

ITEM NO.
12032002



### Water Jars

ITEM NO.	CAPACITY
13069091	250cc
13069054	500cc
13069092	1000cc
13069093	2000cc
13069094	4000cc





Rocking Knife / Rocking Knife Base

13064004  
517mm length, Stainless Steel  
13064018  
Holds rocking knife.



In Pan Cutter

13064019  
6", Used for personal pan pizzas.



Cutting Wheels

ITEM NO.	WHEEL SIZE
13064000	4"
13064001	5"

Heavy duty one piece molded plastic handles, sanitary stainless steel wheels



Notched Cutting Wheel

ITEM NO.	WHEEL SIZE
13064002	2.7"



Volcano Cutting Wheel

ITEM NO.	WHEEL SIZE
13064003	2.9"/2.6"



Dough Crimper

ITEM NO.
12030001



Dough Perforator

12035001  
12035000 Small size  
5" overall length. Use to aerate dough.



Dough Trimmer (Rolling Tool)

12034000  
Used to remove excess dough from pan edge.



Dough Docker 13"

12035002

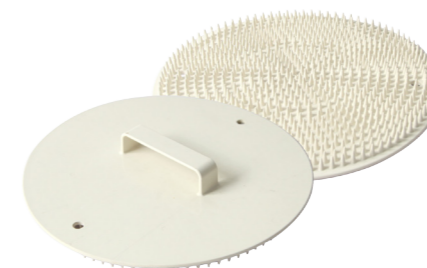

Pan Gripper

13061000  
Cast aluminum alloy with elastomeric spring.



Pizza Servers

ITEM NO.	PACKING	SIZE
13083000	100/Case	2" x 4" blade
13083004	100/Case	2.7" x 8" blade



Portion Cups

ITEM NO.	WATER WEIGHT	Color
12051006	117g	Blue
12051007	165g	Yellow
12051011	190g	Violet
12051013	227g	Green
12051014	273g	Red
12051016	315g	Pink
12051017	360g	Light orange



Sauce Spoodles

ITEM NO.	WATER WEIGHT
12043009	30g
12043000	35g
12043001	54g
12043002	73g
12043003	85g
12043005	122g
12043007	140g



Custom sizes and designs are available.

## Miscellaneous Smallwares

### ■ Pizza Server, Stainless Steel

ITEM NO.
13083001



### ■ Squeeze Bottle

ITEM NO.	CAPACITY
13030001	24 oz



### ■ Check Minders with ball bearing

ITEM NO.	SIZE
13050000	457mm
13050001	600mm
13050002	760mm
13050003	900mm
13050004	1200mm



Made of anodized aluminium that holds up to years of service. They are heat resistant, so they can be mounted above the work area for your convenience. The racks have the plastic end caps with screws to hold the marbles in. Custom sizes are available.

### ■ Thermometers, Pocket

ITEM NO.	RANGE
13054004	0 to 220°F, -10 to 100°C
13054003	- 10 to 100°C
13054002	-40 to 70°C



Recalibration Nut. Plastic watertight lens. Stainless steel construction.

### ■ Sauce Spoon, Stainless Steel

ITEM NO.
13047005



### ■ Salad Crocks

Available in traditional and designer colors and with snap-tight lids for convenient storage.

ITEM NO.	CAPACITY	HEIGHT	TOP DIAMETER
12053000	1.4L	4 3/8"	6 3/4"
12053001	2.5L	6 7/8"	6 3/4"



## Miscellaneous Smallwares

### ■ Salad Tongs / Spoon

Made of revolutionary plastic material for unbearakable strength and longevity.

ITEM NO.	LENGTH
12048000	8.5" / Tong
12048001	12" / Tong

ITEM NO.	LENGTH
12044000	10" / Spoon



### ■ Can Openers

ITEM NO.	DESCRIPITON
13065006	Can Opener, #3
13065002	Portable Can Opener

Open all size and shaped cans up to one gallon. Manual type, fix on side of table. Rotate top handle to open up the can.



### ■ Pizza Pan Rack

ITEM NO.
13023000

Store your pre-made pizzas, ready for the oven, as well as to-go orders. Frees up work area for a faster more efficient operation. 70cm high.

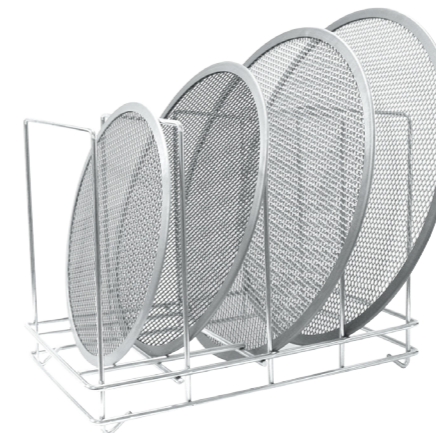

### ■ Pizza Screen Rack

ITEM NO.
13023001

Holds up to 80 screens from the smallest 6" to 18". Takes up only 9"x14" of table space and stands 10.5" high.



### ■ Air Venting Rods

ITEM NO.	SIZE
13010003	5.5"
13010010	6"

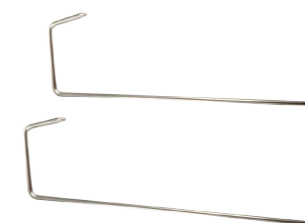

### ■ Salad Bowls / Rack

ITEM NO.
13023002



## Miscellaneous Smallwares

For Delivery

### ■ Pizza Shovels, Wood Handle

ITEM NO.	BLADE SIZE	OVERALL
12019000	12"	28"
12019001	14"	28"
12021003	12"	48"
12021004	14"	48"
12019003	12"	35"



### ■ Pizza Bubble Poppers

ITEM NO.	OVERALL
13006001	39"
13006000	53"



### ■ Rubber Scraper

ITEM NO.	16-1/2" Length. Dishwasher safe.
13060001	



### ■ Chicken Wing Grills

ITEM NO.	SIZE
13056000	140mm
13056002	200mm
13056004	280mm
13056005	300mm

Made of stainless steel.  
Used to grill chicken wings inside deep dish pans.



### ■ Heat Pin

ITEM NO.	PACKING
13117000	36/Case

Heavy weight aluminum for maximum heat transfer.

Place the heat pin in the center of pizza and lasagna.  
Heat pin delivers heat to the center of the pizza for a faster more even bake on deep dish and stuffed pizzas.

Complete unit Dupont non stick coated.

\*Heat Pins should be cleaned after each use. Never scour, Just wipe clean with soft cloth.



a



b



c



d



e

### a Cola Bags

13095001	Large Size
13095002	Small Size

### b Delivery Pouches, Fabric

33001016	Nylon Material
33001005	Thinsulate Material

### c Salad Containers for Delivery and to-go

Custom designs and sizes are available.

### d Lid Support

13034000	2000 / Case
----------	-------------

Prevents delivery box from crushing products.

### e Plastic Fork

DEL-FRK-000	1000 / case
-------------	-------------

## Tablewares

### ■ Pizza Stands

ITEM NO.	DESCRIPTION
13038007	Circle
13038009	Square



### ■ Tumblers

ITEM NO.	DESCRIPTION
12051020	Red 12OZ
12051031	Red 16OZ
12051021	Clear 12OZ
12051036	Clear 22OZ



### ■ Table Menu Stands

STD-PZA-LRG



### ■ Condiment Holder

RAC-CON-000, 3Colors(Silver, Red, Black)  
Keep hot sauce and parmesan cheese on wire rack.



### ■ Cutlery

ITEM NO.	DESCRIPTION
13081004	Dinner Fork
13012000	Dinner Knife
13047021	Dinner Spoon



## Tablewares

### ■ Cola Pitcher, 1700cc

ITEM NO.
12051041

Made of virtually unbreakable polycarbonate.  
Lightweight for easy handling.



### ■ Chicken Baskets

ITEM NO.	COLOR or Material
13038006	Stainless Steel
12071100	Black
12071101	Yellow



### ■ Garlic Bread Baskets

ITEM NO.
13038000



### ■ Organizer Rack With Bins

ITEM NO.
12055SET

Rack with 6 bins 18"x17"x9-5/8" Gray.



### ■ Non Slip Serving Trays

ITEM NO.	SIZE
13078002	14" (357mm) Round
13078020	616" (407mm) Round
13078013	14" x 18" (350 x 447mm) Square





## Regular Steam Table Pans

	PAN SIZE AND DIMENSIONS	ITEM NO.	DESCRIPTION	PACKING
	Full (1/1) Size Pan 20-3/4"x12-3/4" (530x325mm)	13029032	1.2"(32mm)DEEP	12/Case
		13029033	2.5"(65mm)DEEP	12/Case
		13029034	4.0"(100mm)DEEP	12/Case
		13029035	6.0"(150mm)DEEP	12/Case
		13029036	8.0"(200mm)DEEP	12/Case
			Two Third (2/3) Size Pan 13-7/8"x12-3/4" (354x325mm)	13029039
13029040	4.0"(65mm)DEEP			24/Case
13029041	6.0"(100mm)DEEP			12/Case
13029042	8.0"(150mm)DEEP			12/Case
	One Half (1/2) Size Pan 12-3/4"x10-3/8" (325x265mm)	13029045	1.2"(32mm)DEEP	24/Case
		13029046	2.5"(65mm)DEEP	24/Case
		13029047	4.0"(100mm)DEEP	24/Case
		13029048	6.0"(150mm)DEEP	12/Case
		13029049	8.0"(200mm)DEEP	12/Case
	One Third (1/3) Size Pan 12-3/4"x6-7/8" (325x176mm)	13029052	2.5"(65mm)DEEP	48/Case
		13029053	4.0"(100mm)DEEP	24/Case
		13029054	6.0"(150mm)DEEP	24/Case
	One Quarter (1/4) Size Pan 10-3/8"x6-3/8" (265x162mm)	13029057	2.5"(65mm)DEEP	72/Case
		13029058	4.0"(100mm)DEEP	48/Case
		13029059	6.0"(150mm)DEEP	48/Case
	One Sixth (1/6) Size Pan 6-7/8"x6-1/4" (176x162mm)	13029062	2.5"(65mm)DEEP	72/Case
		13029063	4.0"(100mm)DEEP	48/Case
		13029064	6.0"(150mm)DEEP	48/Case
	One Ninth (1/9) Size Pan 6-7/8"x4-1/4" (176x108mm)	13029067	2.5"(65mm)DEEP	72/Case
		13029068	4.0"(100mm)DEEP	72/Case

## Covers

	PAN SIZE	SOLID COVERS	PACKING	SLOTTED COVERS	PACKING
	1/1 Size Coverage	13029037	24 / case	13029038	24 / case
	2/3 Size Coverage	13029043	24 / case	13029044	24 / case
	1/2 Size Coverage	13029050	24 / case	13029051	24 / case
	1/3 Size Coverage	13029055	24 / case	13029056	24 / case
	1/4 Size Coverage	13029060	24 / case	13029061	24 / case
	1/6 Size Coverage	13029065	24 / case	13029066	24 / case
	1/9 Size Coverage	13029069	24 / case	13029070	24 / case

## Polycarbonate Food Pans

	PAN SIZE AND DIMENSIONS	ITEM NO.	DESCRIPTION	PACKING
	Full (1/1) Size Pan 20-3/4"x12-3/4" (530x325mm)	13029000	2.5"(65mm)DEEP	12/Case
		13029001	4.0"(100mm)DEEP	12/Case
		13029002	6.0"(150mm)DEEP	12/Case
		13029003	8.0"(200mm)DEEP	12/Case
	One Half (1/2) Size Pan 12-3/4"x10-3/8" (325x265mm)	13029006	2.5"(65mm)DEEP	24/Case
		13029007	4.0"(100mm)DEEP	24/Case
		13029008	6.0"(150mm)DEEP	12/Case
		13029009	8.0"(200mm)DEEP	12/Case
	One Third (1/3) Size Pan 12-3/4"x6-7/8" (325x176mm)	13029012	2.5"(65mm)DEEP	24/Case
		13029013	4.0"(65mm)DEEP	24/Case
		13029014	6.0"(100mm)DEEP	24/Case
		13029015	8.0"(150mm)DEEP	12/Case
	One Quarter (1/4) Size Pan 10-3/8"x6-3/8" (265x162mm)	13029018	2.5"(65mm)DEEP	36/Case
		13029019	4.0"(100mm)DEEP	36/Case
		13029020	6.0"(150mm)DEEP	24/Case
	One Sixth (1/6) Size Pan 6-7/8"x6-1/4" (176x162mm)	13029023	2.5"(65mm)DEEP	36/Case
		13029024	4.0"(100mm)DEEP	48/Case
		13029025	6.0"(150mm)DEEP	24/Case
	One Ninth (1/9) Size Pan 6-7/8"x4-1/4" (176x108mm)	13029028	2.5"(65mm)DEEP	72/Case
		13029029	4.0"(100mm)DEEP	72/Case

## Covers

	PAN SIZE	SOLID COVERS	PACKING	SLOTTED COVERS	PACKING
	1/1 Size Coverage	13029004	24 / case	13029005	24 / case
	1/2 Size Coverage	13029010	48 / case	13029011	48 / case
	1/3 Size Coverage	13029016	72 / case	13029017	72 / case
	1/4 Size Coverage	13029021	72 / case	13029022	72 / case
	1/6 Size Coverage	13029026	72 / case	13029027	72 / case
	1/9 Size Coverage	13029030	72 / case	13029031	72 / case